

A Unit of Teledyne Electronics and Communications

## MAGNETIC-LATCHING, BROADBAND RF RELAYS SPDT

# SERIES RF341

### DESCRIPTION

The RF341 series relay is an ultraminiature, hermetically sealed, magnetic-latching relay featuring extremely low intercontact capacitance for exceptional RF performance well into the C band. It's low profile and small size make it ideal for applications where extreme packaging density and/or close PC board spacing are required. Due to its minimal mass, many relays may be used to configure replacements for bulkier switching solutions at a substantial savings in weight.

The basic operating mechanism is similar to the TO-5 422 series relay. In addition, the RF341 design has been optimized by increasing the distance between the set/reset contacts. This design improvement makes these unique relays the perfect choice for use in RF attenuators, RF switching matrices and other RF applications requiring high isolation, low insertion loss and low VSWR.

The following unique construction features and manufacturing techniques provide overall high reliability and excellent resistance to environmental extremes:

- Minimum mass components and welded construction provide maximum resistance to shock and vibration.
- Uni-frame motor design provides high magnetic efficiency and mechanical rigidity.
- Advanced cleaning techniques provide maximum assurance of internal cleanliness.
- Gold-plated precious metal contacts ensure reliable, low-level switching.

The RF341 relay is ideally suited for applications where power dissipation must be minimized. The relays can be operated with a short duration pulse. After the contacts have transferred, no external holding power is required. The magnetic latching feature of the RF341 series provides a nonvolatile memory capability since the relays will not reset upon removal of coil power.

### PRINCIPLE OF OPERATION

Energizing Coil B produces a magnetic field opposing the magnetic field of the permanent magnet in Circuit B. As the net holding force decreases, the attractive force in the air gap of Circuit A, which also results from the magnetic field of the permanent magnet, becomes great enough to break the armature free of Core B, and snap it into a closed position against Core A. The armature remains in this position upon removal of power from Coil B, but will snap back into position B upon energizing Coil A. Since operation depends upon cancellation of a magnetic field, it is necessary to apply the correct polarity to the relay coils as indicated on the relay schematic.

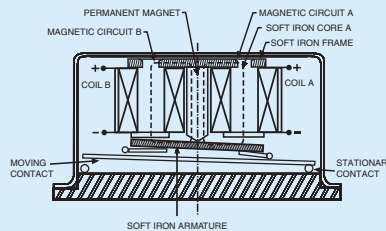

When latching relays are installed in equipment, the latch and reset coils should not be pulsed simultaneously. Coils should not be pulsed with less than rated coil voltage and the pulse width should be a minimum of three times the specified operate time of the relay. If these conditions are not followed, it is possible for the relay to be in the magnetic neutral position. Should this happen, however, pulsing one coil or the other, as prescribed, will bring the relay back into proper operating condition.

### ENVIRONMENTAL AND PHYSICAL SPECIFICATIONS

Temperature (Ambient)	Storage	-65°C to +125°C
	Operating	-55°C to +85°C
Vibration (General Note 1)		30 g's to 2000 Hz
Shock (General Note 1)		75 g's, 6 msec, half-sine
Acceleration		50 g's
Enclosure		Hermetically sealed
Weight		0.09 oz. (2.52g) max.

**SERIES RF341**  
**TYPICAL RF CHARACTERISTICS**

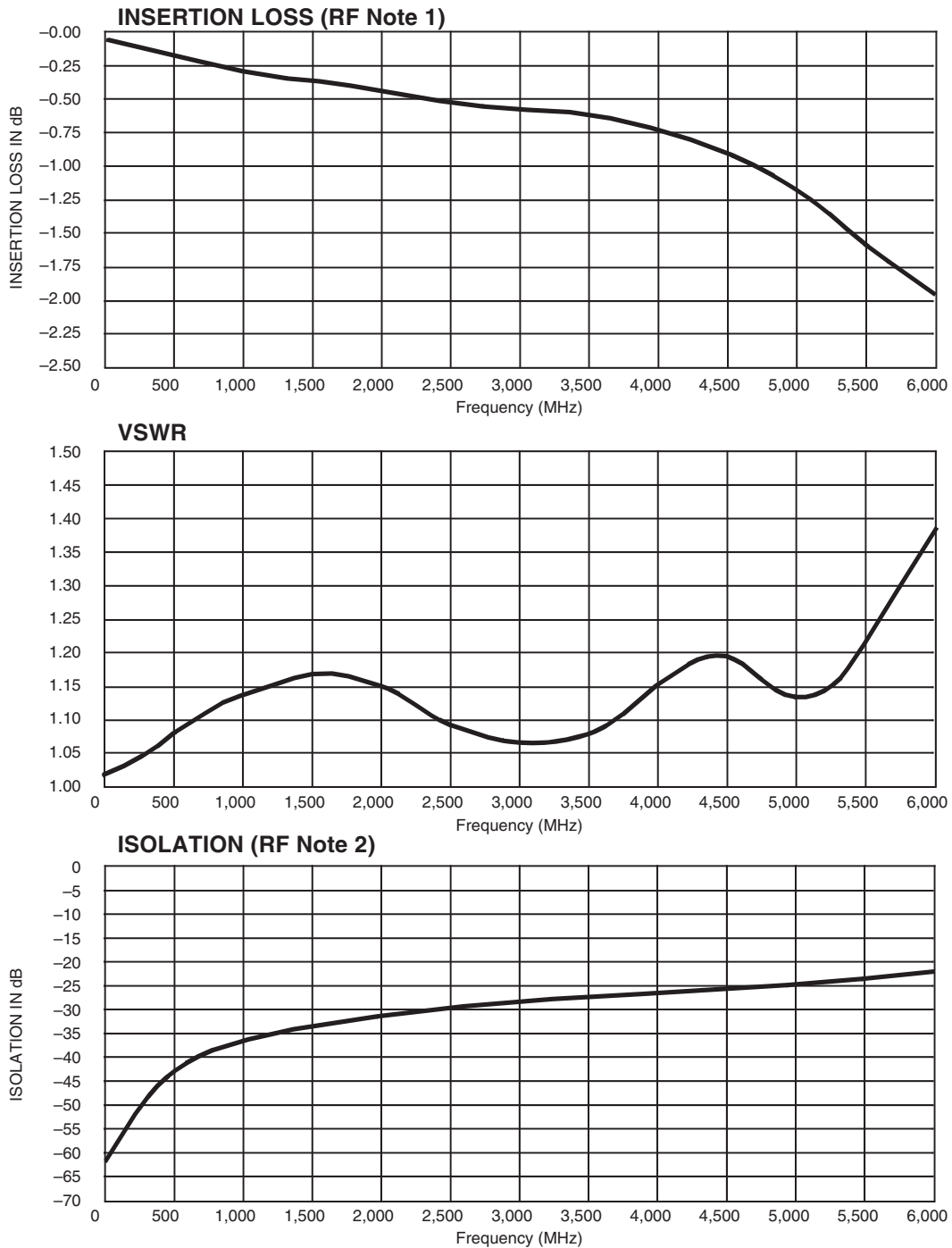

**RF NOTES**

1. Data represents an average between the typical reading of pins 8 and 6 (closed, coil A last energized) and pins 8 and 1 (closed, coil B last energized).
2. Data represents an average between the typical reading of pins 8 and 6 (open, coil B last energized) and pins 8 and 1 (open, coil A last energized).
3. Test conditions:
  - a. Fixture: .031" copper clad, reinforced PTFE, RT/duroid® 6002 with SMA connectors. (RT/duroid® is a registered trademark of Rogers Corporation.)
  - b. Relay header is in contact with, but not soldered to, ground plane or connected to ground via ground pin.
  - c. Test performed at room ambient temperature.
  - d. Terminals not tested were terminated with 50-ohm load.
  - e. Contact signal level: 20 dBm.
4. Data presented herein represents typical characteristics and is not intended for use as specification limits.

## SERIES RF341

## GENERAL ELECTRICAL SPECIFICATIONS (@25°C) (Notes 2 and 3)

Contact arrangement	1 Form C (SPDT)	
Rated duty	Continuous	
Contact resistance	0.15 ohm max. initial. After life, .25 ohms (measured 1/8" from the header)	
Contact load rating (DC)	Low level: 10 to 50 $\mu$ A, 10 to 50 mV	
Contact life rating	10,000,000 cycles typical at low level	
Coil operating power (typical @ nominal rated voltage)	5 volt	410mW
	12 volt	288mW
	26.5 volt	351mW
Operate time	2.0 ms max at nominal rated coil voltage	
Minimum operate pulse	6.0 ms. width max. at rated voltage	
Intercontact capacitance	0.4 pF typical	
Insulation resistance	10,000 M $\Omega$ min. between mutually isolated terminals	
Dielectric strength	350 VRMS/60 Hz @ atmospheric pressure	

## DETAILED ELECTRICAL SPECIFICATIONS (@25°C) (Note 2)

BASE PART NUMBERS		RF341-5	RF341-12	RF341-26
Coil voltage, nominal, VDC	Nom.	5.0	12.0	26.5
	Max.	6.0	16.0	32.0
Coil resistance, ohms $\pm$ 20%		61	500	2,000
Set & reset voltage (VDC max)		3.5	9.0	18.0

## OUTLINE DIMENSIONS AND SCHEMATIC DIAGRAM

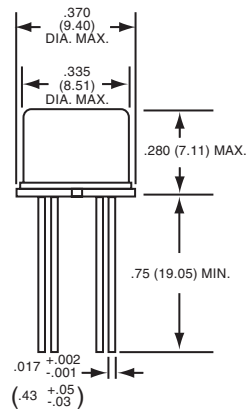

## External Dimensions

DIMENSIONS ARE IN INCHES (MILLIMETERS)

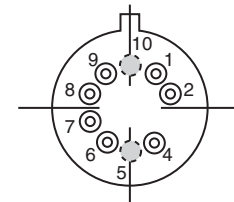
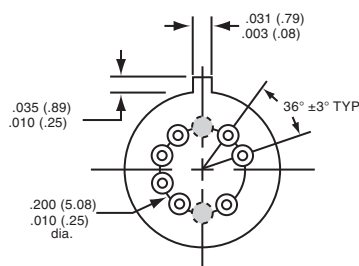

## TERMINAL NUMBERING

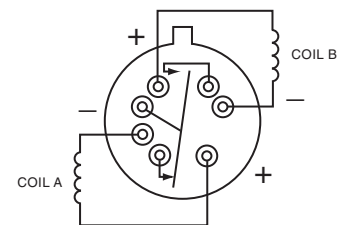

## SCHEMATIC

TERMINAL LOCATION, PIN NUMBERING AND SCHEMATIC ARE VIEWED FROM THE TERMINALS

SCHEMATIC IS SHOWN WITH COIL A LAST ENERGIZED

## GENERAL NOTES

1. Relays will exhibit no contact chatter in excess of 10  $\mu$ sec or transfer in excess of 1  $\mu$ sec.
2. Unless otherwise specified, parameters are initial values.
3. Characteristics shown as "typical" are based on available data and are best estimates. No ongoing verification tests are performed.
4. Pin positions 5 and 10 are recesses in the header for ground pin options (ground pins not shown).
5. To order ground pin options add Y (pin 5 position) or Z (pin 10 position) to the part base part number. **Ex. RF341Y-5**
6. Contact Teledyne Relays for Hi-Rel Screening/Program options.

# Appendix A: Spacer Pads

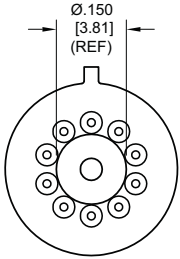
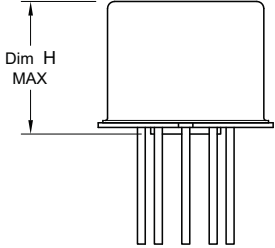
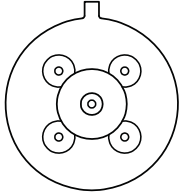
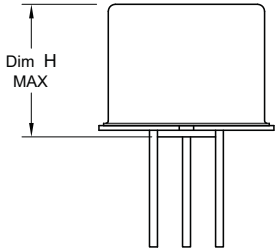
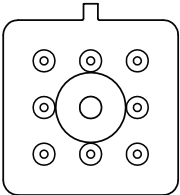
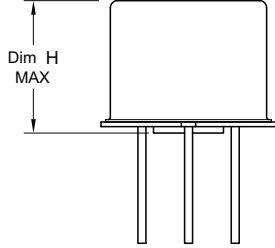
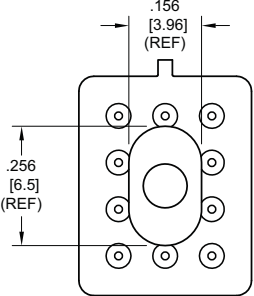
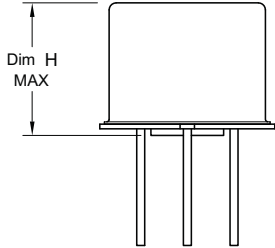
Pad designation and bottom view dimensions	Height	For use with the following:	Dim. H Max.
 <p style="text-align: center;">“M4” Pad for TO-5</p>		ER411T ER412, ER412D, ER412DD	.295 (7.49)
		712, 712D, 712TN, RF300, RF310, RF320	.300 (7.62)
		ER420, ER422D, ER420DD, 421, ER421D, ER421DD, ER422, ER422D, ER422DD, 722, 722D, RF341	.305 (7.75)
		ER431T, ER432T, ER432, ER432D, ER432DD	.400 (10.16)
		732, 732D, 732TN, RF303, RF313, RF323	.410 (10.41)
		RF312	.350 (8.89)
 <p style="text-align: center;">“M4” Pad for TO-5</p>		ER411, ER411D, ER411DD	.295 (7.49)
		ER431, ER431D, ER431DD	.400 (10.16)
		RF311	.300 (7.62)
		RF331	.410 (10.41)
 <p style="text-align: center;">“M4” Pad for Centigrid®</p>		172, 172D	.305 (7.75)
		ER114, ER114D, ER114DD, J114, J114D, J114DD	.300 (7.62)
		ER134, ER134D, ER134DD, J134, J134D, J134DD	.400 (10.16)
		RF100	.315 (8.00)
		RF103	.420 (10.67)
 <p style="text-align: center;">“M9” Pad for Centigrid®</p>		122C, A152	.320 (8.13)
		ER116C, J116C	.300 (7.62)
		ER136C, J136C	.400 (10.16)
		RF180	.325 (8.25)
		A150	.305 (7.75)

**Notes:**

1. Spacer pad material: Polyester film.
2. To specify an “M4” or “M9” spacer pad, refer to the mounting variants portion of the part numbering example in the applicable datasheet.
3. Dimensions are in inches (mm).
4. Unless otherwise specified, tolerance is  $\pm .010$  (.25).
5. Add 10 m $\Omega$  to the contact resistance show in the datasheet.
6. Add 0.01 oz. (0.25 g) to the weight of the relay assembly shown in the datasheet.

# Appendix A: Spreader Pads

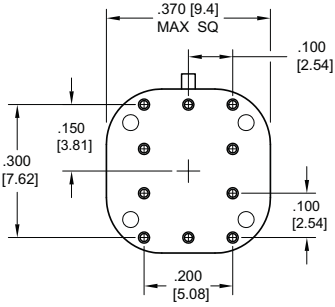
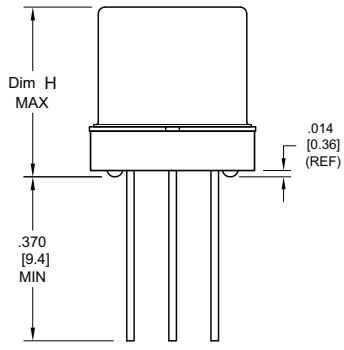
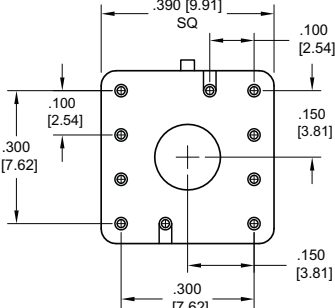
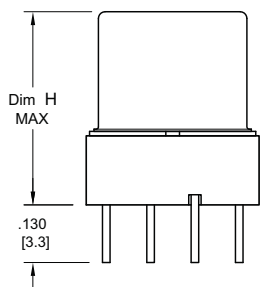
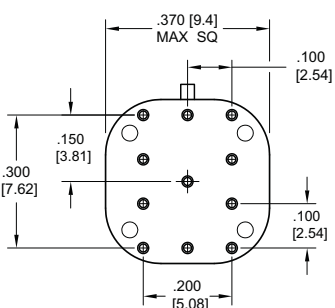
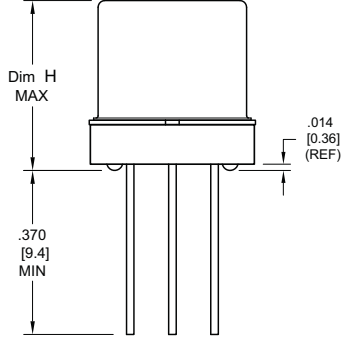
Pad designation and bottom view dimensions	Height	For use with the following:	Dim. H Max.
 <p>“M” Pad <u>5/</u> <u>6/</u> <u>9/</u></p>		ER411T, J411T, ER412, ER412D ER412DD, J412, J412D, J412DD ER412T, J412T	.388 (9.86)
		712, 712D, 712TN	.393 (9.99)
		ER431T, J431T, ER432, ER432D ER432DD, J432, J432D, J432DD ER432T, J432T	.493 (12.52)
		732, 732D, 732TN	.503 (12.78)
		ER420, J420, ER420D, J420D ER420DD, J420DD, ER421, J421 ER421D, J421D, ER421DD J422D, ER422DD, J422DD, 722	.398 (10.11)
 <p>“M2” Pad <u>7/</u> <u>8/</u></p>		ER411T ER412, ER412D, ER412DD J412, J412D, J412DD	.441 (11.20)
		712, 712D	.451 (11.46)
		ER421, ER421D, ER421DD 722, 732D	.451 (11.46)
		ER431T ER432, ER432D, ER432DD	.546 (13.87)
		732, 732D	.556 (14.12)
 <p>“M3” Pad <u>5/</u> <u>6/</u> <u>9/</u></p>		ER411, ER411D, ER411DD ER411TX ER412X, ER412DX, ER412DDX ER412TX	.388 (9.86)
		712X, 712DX, 712TNX	.393 (9.99)
		ER420X, ER420DX, ER420DDX ER421X, ER421DX, ER421DDX ER422X, ER422DX ER422DDX, 722X, 722DDX	.398 (10.11)
		ER431, ER431D, ER431DD ER431TX ER432X, ER432DX, ER432DDX ER432TX	.493 (12.52)
		732X, 732DX, 732TNX	.503 (12.78)

## Notes:

1. Spreader pad material: Diallyl Phthalate.
2. To specify an “M”, “M2” or “M3” spreader pad, refer to the mounting variants portion of the part number example in the applicable datasheet.
3. Dimensions are in inches (mm).
4. Unless otherwise specified, tolerance is  $\pm .010$ ” (0.25).
- 5/. Add 25 mΩ to the contact resistance shown in the datasheet.
- 6/. Add .01 oz. (0.25 g) to the weight of the relay assembly shown in the datasheet.
- 7/. Add 50 mΩ to the contact resistance shown in the datasheet.
- 8/. Add 0.025 oz (0.71 g) to the weight of the relay assembly shown in the datasheet.
- 9/. M3 pad to be used only when the relay has a center pin (e.g. ER411M3-12A, 722XM3-26.)

# Appendix A: Ground Pin Positions

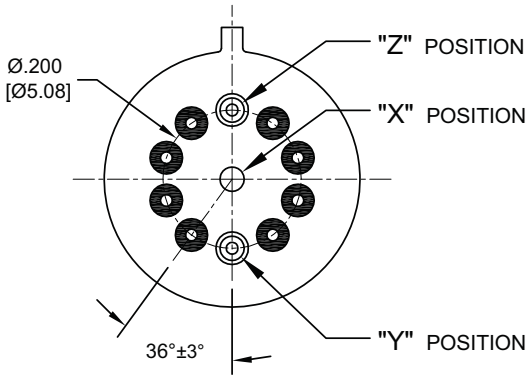

### TO-5 Relays:

ER411T, ER412, ER412T, ER420, ER421, ER422,  
ER431T, ER432, ER432T, 712, 712TN, 400H, 400K,  
400V, RF300, RF303, RF341, RF312, RF310, RF313,  
RF320, RF323

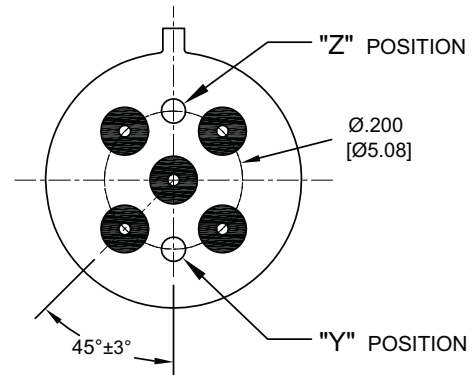

### TO-5 Relays:

ER411, ER431, RF311, RF331

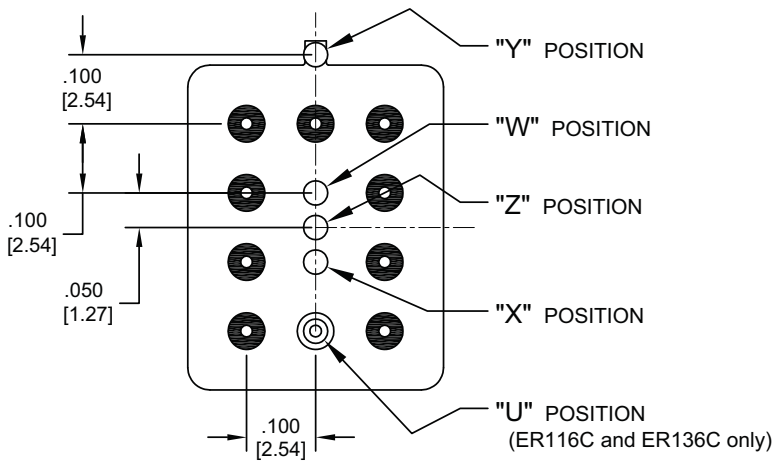

### Centigrad® Relays:

RF180, ER116C, 122C, ER136C

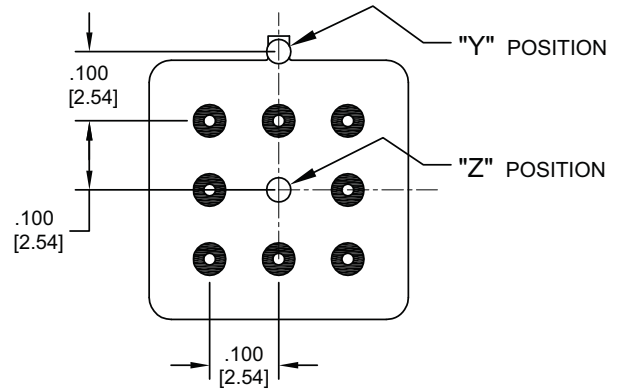

### Centigrad® Relays:

RF100, RF103, ER114, ER134, 172

- Indicates ground pin position
- Indicates glass insulated lead position
- ⊙ Indicates ground pin or lead position depending on relay type

### NOTES

1. Terminal views shown
2. Dimensions are in inches (mm)
3. Tolerances:  $\pm .010$  ( $\pm .25$ ) unless otherwise specified
4. Ground pin positions are within  $.015$  ( $0.38$ ) dia. of true position
5. Ground pin head dia.,  $0.035$  ( $0.89$ ) ref: height  $0.010$  ( $0.25$ ) ref.
6. Lead dia.  $0.017$  ( $0.43$ ) nom.