



A Unit of Teledyne Electronics and Communications

HIGH-SHOCK, HIGH-PERFORMANCE TO-5 RELAY DPDT

SERIES 412K 422K

| SERIES DESIGNATION | RELAY TYPE |
|--------------------|---|
| 412K | DPDT high-shock relay |
| 422K | DPDT high-shock magnetic-latching relay |

INTERNAL CONSTRUCTION

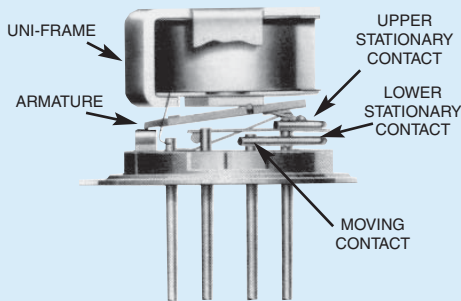

DESCRIPTION

The TO-5 relay, originally conceived and developed by Teledyne, has become one of the industry standards for low-level switching from dry circuit to 1 ampere. Designed for high-density PC board mounting, its small size and low coil power dissipation make the TO-5 relay one of the most versatile subminiature relays available.

The K Series high-shock TO-5 relays are designed to withstand shock levels up to 4000 g's, .5 millisecond duration. Special material selection and construction details provide assurance that critical elements of the relay structure and mechanism will not be permanently displaced or damaged as a result of extremely high g level shocks.

Typical applications:

- Commercial avionics aircraft control
- Commercial aircraft control systems
- Transportation systems (rail/truck)

By virtue of their inherently low intercontact capacitance and contact circuit losses, the K Series relays have proven to be excellent subminiature RF switches for applications with frequency ranges well into the UHF spectrum. A typical RF application for the TO-5 relay is in handheld radio transceivers, wherein the combined features of good RF performance, small size, low coil power dissipation and high reliability make it a preferred method of T-R switching (see Figure 1 and 2).

412K ENVIRONMENTAL AND PHYSICAL SPECIFICATIONS

| | |
|----------------------------|---|
| Temperature (Ambient) | -65°C to +125°C |
| Vibration (General Note 1) | 30 g's to 3000 Hz |
| Shock | (General Note 1) 75 g's, 6 msec, half-sine |
| | (General Note 4) 4000 g's, 0.5 msec. axial plane, half-sine 1000 g's, 0.5 msec side planes, half-sine |
| Acceleration | 50 g's |
| Enclosure | Hermetically sealed |
| Weight | 0.09 oz. (2.55g) max. |

422K ENVIRONMENTAL AND PHYSICAL SPECIFICATIONS

| | |
|----------------------------|--|
| Temperature (Ambient) | -65°C to +125°C |
| Vibration (General Note 1) | 30 g's to 3000 Hz |
| Shock | (General Note 1) 100 g's, 6 msec, half-sine |
| | (General Note 4) 2100 g's, 0.5 msec. axial plane, half-sine 750 g's, 0.5 msec side planes, half-sine |
| Acceleration | 50 g's |
| Enclosure | Hermetically sealed |
| Weight | 0.10 oz. (2.84g) max. |

PRINCIPLE OF OPERATION 422K

Energizing Coil B produces a magnetic field opposing the holding flux of the permanent magnet in Circuit B. As this net holding force decreases, the attractive force in the air gap of circuit A, which also results from the flux of the permanent magnet, becomes great enough to break the armature free of Core B, and snap it into a closed position against Core A. The armature then remains in this position upon removal of power from Coil B, but will snap back to position B upon energizing Coil A. Since operation depends upon cancellation of a magnetic field, it is necessary to apply the correct polarity to the relay coils as indicated on the relay schematic.

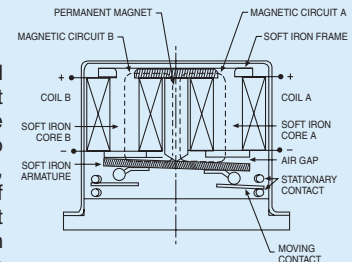

When latching relays are installed in equipment, the latch and reset coils should not be pulsed simultaneously. Coils should not be pulsed with less than rated coil voltage and the pulse width should be a minimum of three times the specified operate time of the relay. If these conditions are not followed it is possible for the relay to be in the magnetically neutral position.

SERIES 412K/422K

GENERAL ELECTRICAL SPECIFICATIONS (-65°C to +125°C unless otherwise noted) (Notes 2 & 3)

| | | |
|---|--|---------------------------|
| Contact Arrangement | 2 Form C (DPDT) | |
| Rated Duty | Continuous | |
| Contact Resistance | 412K: 0.1 ohms max. before life; 0.2 ohms max. after life at 1A/28Vdc 422K: 0.15 ohms max. before life; .225 ohms max after life at 1A/28Vdc } measured 1/8" below header | |
| Contact Load Ratings (DC) (See Fig. 3 for other DC resistive voltage/current ratings) | Resistive: 1 Amp/28Vdc Inductive: 200 mA/28Vdc (320 mH) Lamp: 100 mA/28Vdc Low Level: 10 to 50µA/10 to 50mV | |
| Contact Load Ratings (AC) | Resistive: 250 mA/115Vac, 60 and 400 Hz (Case not grounded) 100 mA/115Vac, 60 and 400 Hz (Case grounded) | |
| Contact Life Ratings (Note 6) | 10,000,000 cycles (typical) at low level 1,000,000 cycles (typical) at 0.5A/28Vdc resistive 100,000 cycles min. at all other loads specified above | |
| Contact Overload Rating | 2A/28Vdc Resistive (100 cycles min.) | |
| Contact Carry Rating | Contact factory | |
| Coil Operating Power | 412K: 500 mW typ. @ 25°C | 422K: 290 mW typ. @ 25°C |
| Operate Time | 412K: 2.0 msec max. | 422K: 1.5 msec max. |
| Release Time | 1.5 msec max. (412K only) | |
| Contact Bounce | 1.5 msec max. | |
| Intercontact Capacitance | 0.4 pf typical | |
| Insulation Resistance | 10,000 megohms min. between mutually isolated terminals | |
| Dielectric Strength | Atmospheric pressure: 500 Vrms/60Hz | 70,000 ft.: 125 Vrms/60Hz |
| Minimum Operate Pulse | 4.5 msec width @ rated voltage (422K only) | |

412K SERIES RELAY

DETAILED ELECTRICAL SPECIFICATIONS (-65°C to +125°C unless otherwise noted) (Note 2)

| BASE PART NUMBERS → | | 412K-5 | 412K-6 | 412K-9 | 412K-12 | 412K-18 | 412K-26 |
|--|------|--------|--------|--------|---------|---------|---------|
| Coil Voltage (Vdc) | Nom. | 5.0 | 6.0 | 9.0 | 12.0 | 18.0 | 26.5 |
| | Max. | 5.8 | 8.0 | 12.0 | 16.0 | 24.0 | 32.0 |
| Coil Resistance (Ohms ±10% @25°C) | | 50 | 80 | 160 | 300 | 600 | 1350 |
| Pick-up Voltage (Vdc, Max.) | | 4.3 | 5.2 | 7.6 | 10.0 | 14.3 | 21.0 |
| Drop-out Voltage (Vdc) | Min. | 0.14 | 0.18 | 0.35 | 0.41 | 0.59 | 0.89 |
| | Max. | 2.5 | 3.2 | 4.9 | 6.5 | 10.0 | 13.0 |

422K SERIES RELAY

DETAILED ELECTRICAL SPECIFICATIONS (-65°C to +125°C unless otherwise noted) (Note 2)

| BASE PART NUMBERS → | | 422K-5 | 422K-6 | 422K-9 | 422K-12 | 422K-18 | 422K-26 |
|--|------|--------|--------|--------|---------|---------|---------|
| Coil Voltage (Vdc) | Nom. | 5.0 | 6.0 | 9.0 | 12.0 | 18.0 | 26.5 |
| | Max. | 5.8 | 8.0 | 12.0 | 16.0 | 24.0 | 32.0 |
| Coil Resistance (Ohms ±10% @25°C) | | 61 | 120 | 280 | 500 | 1130 | 2000 |
| Set & Reset Voltage (Vdc, Max.) | | 3.5 | 4.5 | 6.8 | 9.0 | 13.5 | 18.0 |

HIGH-PERFORMANCE

PERFORMANCE CURVES
(NOTE 2)

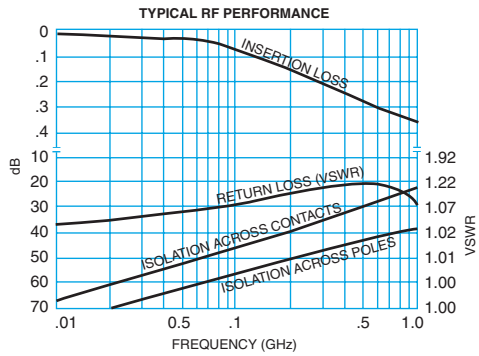

FIGURE 1 (412K)

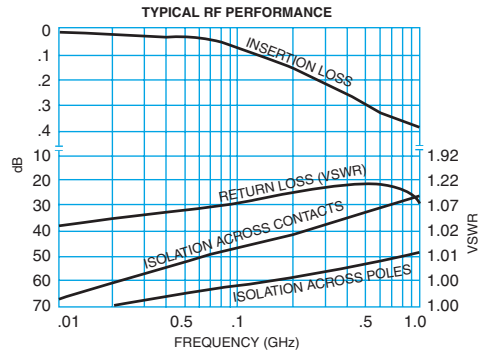

FIGURE 2 (422K)

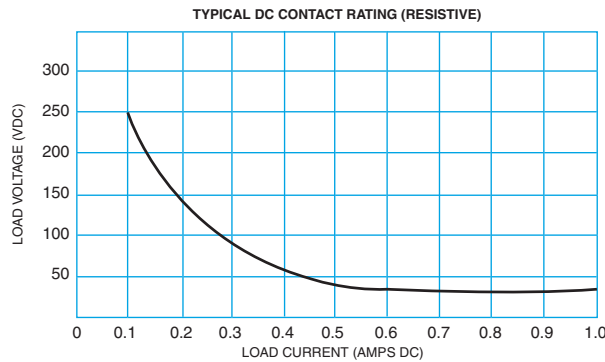
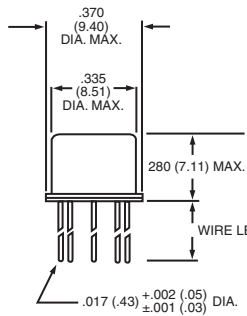

FIGURE 3

HIGH-PERFORMANCE

OUTLINE DIMENSIONS



TERMINAL LOCATIONS AND PIN NUMBERS (REF. ONLY)
(Viewed from Terminals)

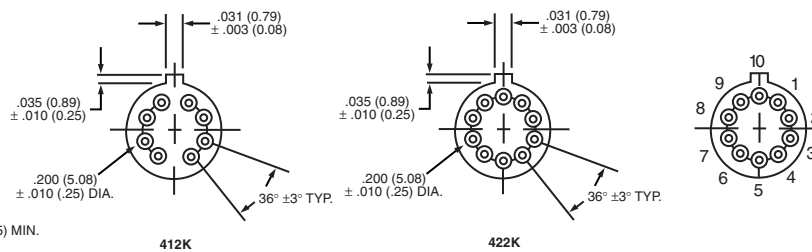

DIMENSIONS ARE SHOWN IN INCHES (MILLIMETERS)

SCHEMATIC DIAGRAMS

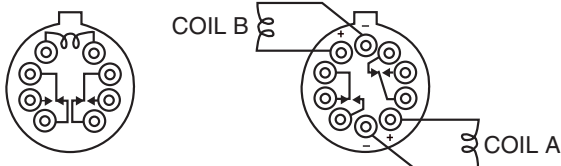

412K

422K

CONTACTS SHOWN IN POSITION RESULTING WHEN COIL A LAST ENERGIZED.

SCHEMATICS ARE VIEWED FROM TERMINALS

GENERAL NOTES

1. Relay contacts will exhibit no chatter in excess of 10 μ sec or transfer in excess of 1 μ sec.
2. "Typical" characteristics are based on available data and are best estimates. No on-going verification tests are performed.
3. Unless otherwise specified, parameters are initial values.
4. Survival only — contact chatter may occur.

Appendix A: Spacer Pads

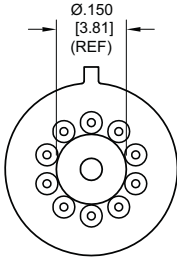
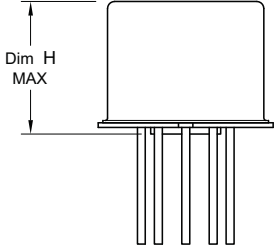
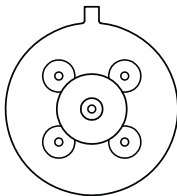
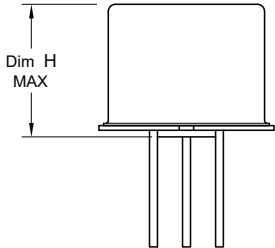
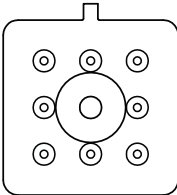
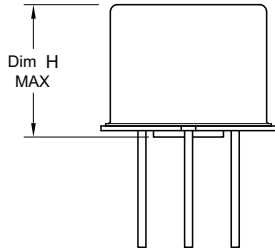
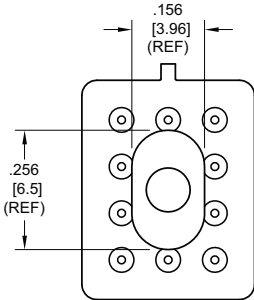
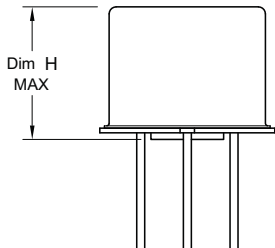
| Pad designation and bottom view dimensions | Height | For use with the following: | Dim. H Max. |
|--|---|--|--------------|
|  <p style="text-align: center;">“M4” Pad for TO-5</p> |  | ER411T ER412, ER412D, ER412DD | .295 (7.49) |
| | | 712, 712D, 712TN, RF300, RF310, RF320 | .300 (7.62) |
| | | ER420, ER422D, ER420DD, 421, ER421D, ER421DD, ER422, ER422D, ER422DD, 722, 722D, RF341 | .305 (7.75) |
| | | ER431T, ER432T, ER432, ER432D, ER432DD | .400 (10.16) |
| | | 732, 732D, 732TN, RF303, RF313, RF323 | .410 (10.41) |
| | | RF312 | .350 (8.89) |
|  <p style="text-align: center;">“M4” Pad for TO-5</p> |  | ER411, ER411D, ER411DD | .295 (7.49) |
| | | ER431, ER431D, ER431DD | .400 (10.16) |
| | | RF311 | .300 (7.62) |
| | | RF331 | .410 (10.41) |
|  <p style="text-align: center;">“M4” Pad for Centigrid®</p> |  | 172, 172D | .305 (7.75) |
| | | ER114, ER114D, ER114DD, J114, J114D, J114DD | .300 (7.62) |
| | | ER134, ER134D, ER134DD, J134, J134D, J134DD | .400 (10.16) |
| | | RF100 | .315 (8.00) |
| | | RF103 | .420 (10.67) |
|  <p style="text-align: center;">“M9” Pad for Centigrid®</p> |  | 122C, A152 | .320 (8.13) |
| | | ER116C, J116C | .300 (7.62) |
| | | ER136C, J136C | .400 (10.16) |
| | | RF180 | .325 (8.25) |
| | | A150 | .305 (7.75) |

Notes:

1. Spacer pad material: Polyester film.
2. To specify an “M4” or “M9” spacer pad, refer to the mounting variants portion of the part numbering example in the applicable datasheet.
3. Dimensions are in inches (mm).
4. Unless otherwise specified, tolerance is $\pm .010$ (.25).
5. Add 10 m Ω to the contact resistance show in the datasheet.
6. Add 0.01 oz. (0.25 g) to the weight of the relay assembly shown in the datasheet.

Appendix A: Spreader Pads

| Pad designation and bottom view dimensions | Height | For use with the following: | Dim. H Max. |
|---|--------|---|--------------|
| <p style="text-align: center;">“M” Pad <u>5/</u> <u>6/</u> <u>9/</u></p> | | ER411T, J411T, ER412, ER412D ER412DD, J412, J412D, J412DD ER412T, J412T | .388 (9.86) |
| | | 712, 712D, 712TN | .393 (9.99) |
| | | ER431T, J431T, ER432, ER432D ER432DD, J432, J432D, J432DD ER432T, J432T | .493 (12.52) |
| | | 732, 732D, 732TN | .503 (12.78) |
| | | ER420, J420, ER420D, J420D ER420DD, J420DD, ER421, J421 ER421D, J421D, ER421DD J422D, ER422DD, J422DD, 722 | .398 (10.11) |
| <p style="text-align: center;">“M2” Pad <u>7/</u> <u>8/</u></p> | | ER411T ER412, ER412D, ER412DD J412, J412D, J412DD | .441 (11.20) |
| | | 712, 712D | .451 (11.46) |
| | | ER421, ER421D, ER421DD 722, 732D | .451 (11.46) |
| | | ER431T ER432, ER432D, ER432DD | .546 (13.87) |
| | | 732, 732D | .556 (14.12) |
| <p style="text-align: center;">“M3” Pad <u>5/</u> <u>6/</u> <u>9/</u></p> | | ER411, ER411D, ER411DD ER411TX ER412X, ER412DX, ER412DDX ER412TX | .388 (9.86) |
| | | 712X, 712DX, 712TNX | .393 (9.99) |
| | | ER420X, ER420DX, ER420DDX ER421X, ER421DX, ER421DDX ER422X, ER422DX ER422DDX, 722X, 722DDX | .398 (10.11) |
| | | ER431, ER431D, ER431DD ER431TX ER432X, ER432DX, ER432DDX ER432TX | .493 (12.52) |
| | | 732X, 732DX, 732TNX | .503 (12.78) |

Notes:

1. Spreader pad material: Diallyl Phthalate.
2. To specify an “M”, “M2” or “M3” spreader pad, refer to the mounting variants portion of the part number example in the applicable datasheet.
3. Dimensions are in inches (mm).
4. Unless otherwise specified, tolerance is $\pm .010$ ” (0.25).
- 5/. Add 25 mΩ to the contact resistance shown in the datasheet.
- 6/. Add .01 oz. (0.25 g) to the weight of the relay assembly shown in the datasheet.
- 7/. Add 50 mΩ to the contact resistance shown in the datasheet.
- 8/. Add 0.025 oz (0.71 g) to the weight of the relay assembly shown in the datasheet.
- 9/. M3 pad to be used only when the relay has a center pin (e.g. ER411M3-12A, 722XM3-26.)

Appendix A: Ground Pin Positions



TO-5 Relays:

ER411T, ER412, ER412T, ER420, ER421, ER422,
ER431T, ER432, ER432T, 712, 712TN, 400H, 400K,
400V, RF300, RF303, RF341, RF312, RF310, RF313,
RF320, RF323



TO-5 Relays:

ER411, ER431, RF311, RF331



Centigrid® Relays:

RF180, ER116C, 122C, ER136C



Centigrid® Relays:

RF100, RF103, ER114, ER134, 172

- Indicates ground pin position
- Indicates glass insulated lead position
- ◎ Indicates ground pin or lead position depending on relay type

NOTES

1. Terminal views shown
2. Dimensions are in inches (mm)
3. Tolerances: $\pm .010$ ($\pm .25$) unless otherwise specified
4. Ground pin positions are within $.015$ (0.38) dia. of true position
5. Ground pin head dia., 0.035 (0.89) ref: height 0.010 (0.25) ref.
6. Lead dia. 0.017 (0.43) nom.