



ULTRAMINIATURE BROADBAND ATTENUATOR RELAYS



SERIES	RELAY TYPE
A152	Attenuator Relay series, DC- 5 GHz

DESCRIPTION

The Series A152 highly repeatable ultraminiature attenuator relays are designed for attenuating RF signals in 50-ohm systems over a frequency range from DC to 5 GHz. Their low profile and small grid spacing makes them ideal for use when packaging density is a prime consideration. The A152 relays eliminate the need for additional external resistors/attenuators.

These single section, switchable attenuator relays have an internal matched thin film attenuator pad in a "Pi" configuration. Relays are available in a fixed increment of 20 dB.

The A152 feature:

- Unique uni-frame motor design which provides high magnetic efficiency and mechanical rigidity.
- Minimum mass components and welded construction for maximum resistance to shock and vibration.
- Advanced cleaning techniques which assures internal cleanliness.
- Gold plated, precious metal contacts, which provide excellent intermodulation performance.
- Flat amplitude vs. frequency response.
- High isolation between control and signal path.
- Stable attenuation vs. temperature.
- Excellent phase linearity.
- Highly resistant to ESD.

Patent No. 5,315,273

Part Numbering System

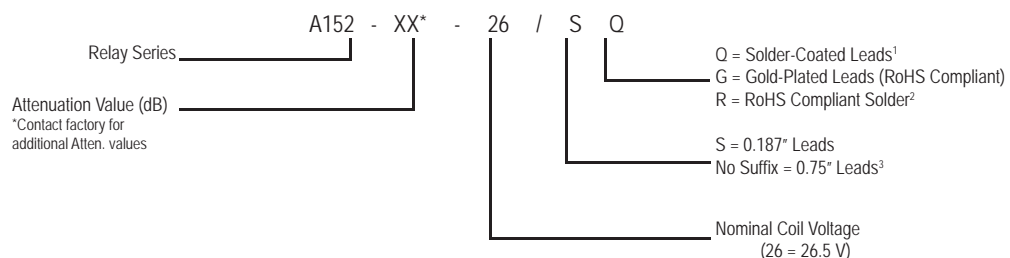

Note: Parts ordered without suffix may be supplied with Solder-Coated or Gold-Plated leads.

1 Parts ordered with Solder-Coated leads will have (Sn60/Pb40)

2 Parts ordered with RoHS Solder-Coated leads will have (Sn99.3/Cu0.7)

ENVIRONMENTAL AND PHYSICAL SPECIFICATIONS

Temperature (Ambient)	-65°C to +125°C
Vibration (General Note I)	10 g's to 2000 Hz
Shock (General Note I)	30 g's, 6ms half sine
Enclosure	Hermetically sealed
Weight	0.11 oz. (3.12g) max.

INTERNAL CONSTRUCTION

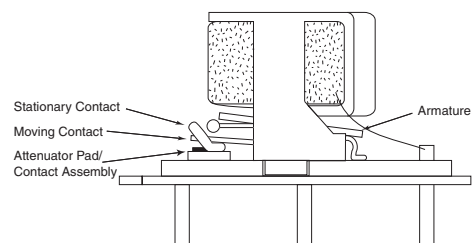

SERIES A152
GENERAL ELECTRICAL SPECIFICATIONS (@25°C)

Contact Life Ratings	10,000,000 cycles (typical) at low level	
Operate Time (Note 8)	Max.	4.0 msec max. at nominal rated coil voltage
	Typ.	2.0 msec max. at nominal rated coil voltage
Insulation Resistance	1,000 MΩ min. between mutually isolated terminals	
Dielectric Strength	350 Vrms (60 Hz) @ atmospheric pressure	

DETAILED ELECTRICAL SPECIFICATIONS (@25°C)

BASE PART NUMBERS (A152)		A152-dB-5	A152-dB-12	A152-dB-15	A152-dB-26
Coil Voltage (Vdc)	Nom.	5.0	12.0	15	26.5
	Max.	5.8	16.0	20.0	32.0
Coil Resistance (Ohms ±20%)		50	390	610	1,560
Pick-Up Voltage (Vdc, Max.)		3.8	9.0	11.3	18.0

GENERAL PERFORMANCE (-55°C to +85°C)

PARAMETER	MINIMUM	TYPICAL	MAXIMUM
Operating Frequency (GHz)	0.0	-	5.0
Power (W) (Notes 5 and 6)	-	-	1.0
Impedance (Ω)	-	50	-

SERIES A152
RF Performance (-55°C to +85°C)

BASE PART NUMBERS (RF180)	RANGE	TYPICAL	MAXIMUM
Insertion Loss (dB)	DC - 1 GHz	0.1	0.25
	1 - 2 GHz	0.2	0.35
	2 - 3 GHz	0.3	0.055
	3-5 GHz	See Graph	
VSWR (Through Path)	DC - 1 GHz	1.10	1.20
	1 - 2 GHz	1.20	1.25
	2 - 3 GHz	1.25	1.30
	3-5 GHz	See Graph	
VSWR (Attenuated Path)	DC - 1 GHz	1.20	1.25
	1 - 2 GHz	1.30	1.35
	2 - 3 GHz	1.40	1.45
	3-5 GHz	See Graph	

ATTENUATION (dB)	RANGE	MINIMUM	TYPICAL	MAXIMUM
5	DC - 1 GHz	4.75	5.0	5.25
	1 - 2 GHz	4.62	5.0	5.38
	2 - 3 GHz	4.37	5.0	5.63
20	DC - 1 GHz	19.8	20.0	20.2
	1 - 2 GHz	19.6	20.0	20.4
	2 - 3 GHz	19.0	20.0	21.0

TYPICAL RF CHARACTERISTICS

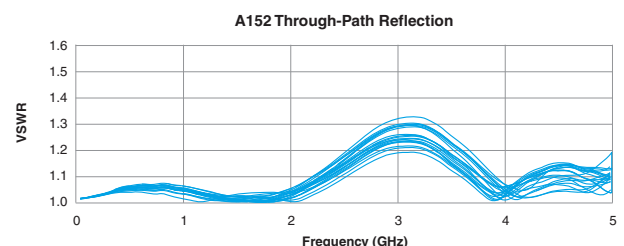
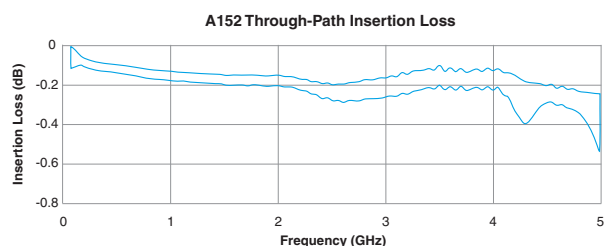
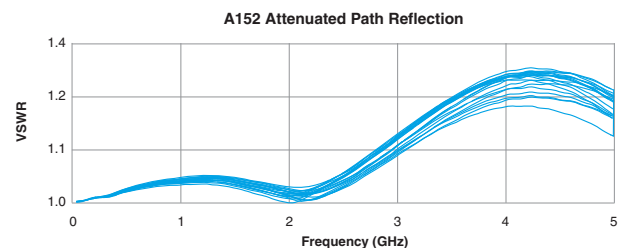
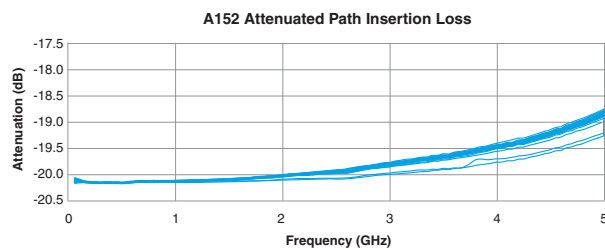

SERIES A152
TYPICAL RF INSERTION LOSS REPEATABILITY CHARACTERISTICS

**A152 Insertion Loss Repeatability
(Through Path)**

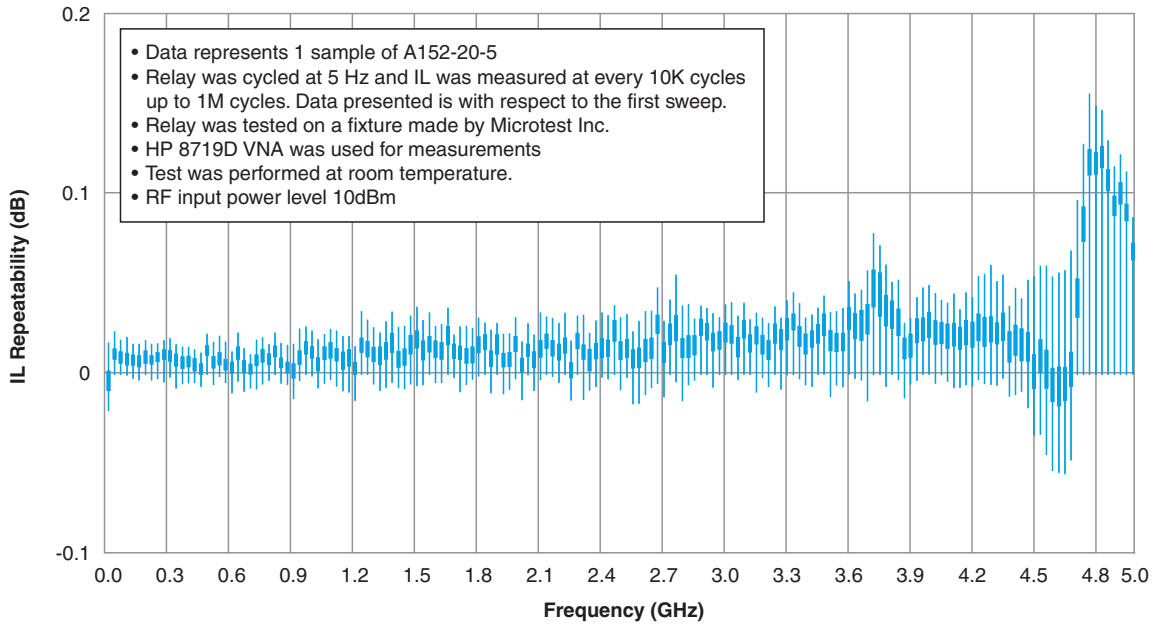

**A152 Insertion Loss Repeatability
(Attenuated Path)**

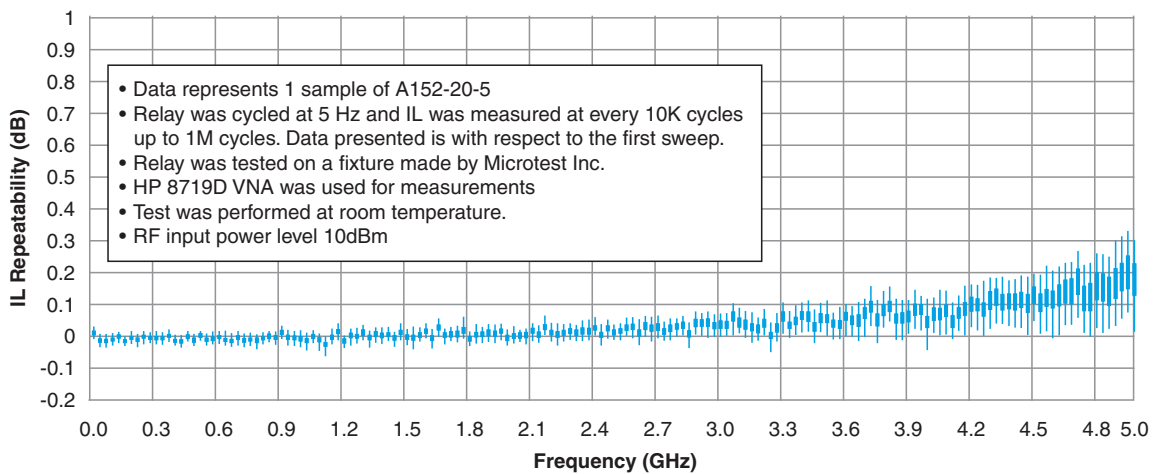

RF INSERTION LOSS REPEATABILITY NOTES

1. TEST CONDITIONS:
 - a. FIXTURE: CUSTOM PLUG-IN TEST FIXTURE.
 - b. RELAY HEADER IS IN CONTACT WITH, BUT NOT SOLDERED TO, GROUND PLANE.
 - c. TEST PERFORMED AT ROOM AMBIENT TEMPERATURE.
 - d. CONTACT SIGNAL LEVEL: 10 DBM.
2. DATA PRESENTED HEREIN REPRESENTS TYPICAL CHARACTERISTICS AND IS NOT INTENDED FOR USE AS SPECIFICATION LIMITS.
3. INSERTION LOSS REPEATABILITY MEASURED OVER FREQUENCY RANGE FROM 3 MHZ TO 5 GHZ.

SERIES A152 OUTLINE DIMENSIONS

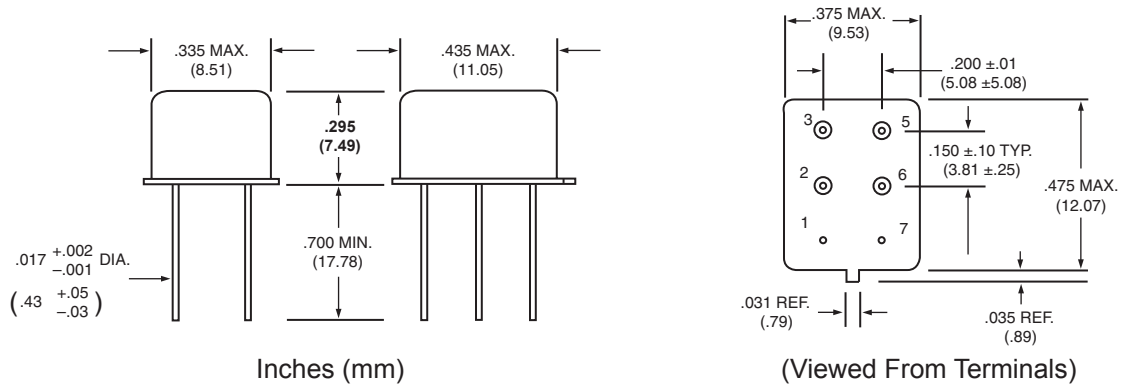

A152 SCHEMATIC DIAGRAMS

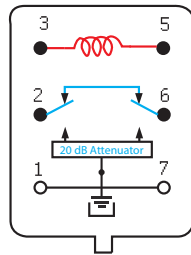

NOTES:

1. Contacts will exhibit no contact chatter in excess of 10 μ s or transfer in excess of 1 μ s.
2. Relays may be operated at higher frequencies with reduced RF performance.
3. For optimal RF performance, solder case to RF ground plane.
4. Attenuation values shown are with reference to the through path (low loss state).
5. Power handling for case temperatures of -55°C to $+55^{\circ}\text{C}$ is 1 Watt. Derate power handling 25 mW/ $^{\circ}\text{C}$ above $+55^{\circ}\text{C}$. Case measurement point is adjacent to the relay tab.
6. Do not operate coil at maximum coil voltage continuously.
7. Insert attenuation value, see part numbering system.
8. Switching time includes bounce.
9. The slash and characters appearing after the slash are not marked on the relay.
10. Unless otherwise specified, relays will be supplied with either gold-plated or solder-coated leads.

APPENDIX: Spacer Pads

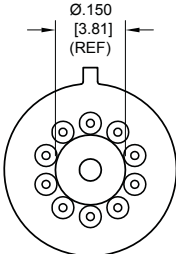
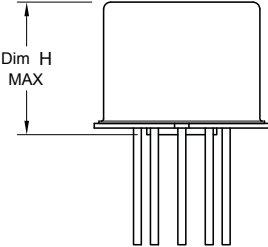
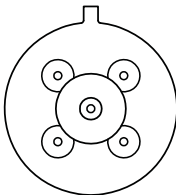
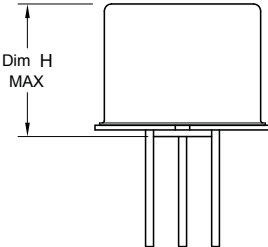
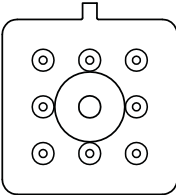
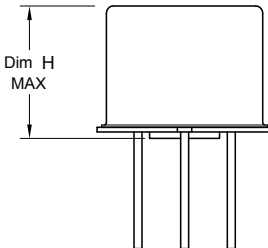
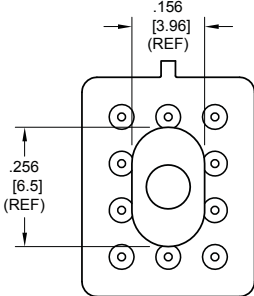
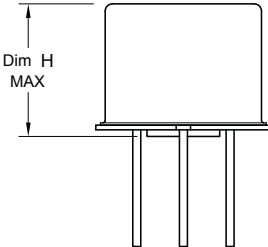
Pad designation and bottom view dimensions	Height	For use with the following:	Dim. H Max.
 <p style="text-align: center;">“M4” Pad for TO-5</p>		ER412, ER412D, ER412DD	.295 (7.49)
		712, 712D, 712TN, RF300, RF310, RF320 RF700, RF703	.300 (7.62)
		ER420, ER420D, ER420DD, 421, ER421D, ER421DD, ER422, ER422D, ER422DD, 722, 722D, RF341	.305 (7.75)
		ER431T, ER432T, ER432, ER432D, ER432DD	.400 (10.16)
		732, 732D, 732TN, RF303, RF313, RF323	.410 (10.41)
		RF312, RF332 SI800, SI803	.350 (8.89)
 <p style="text-align: center;">“M4” Pad for TO-5</p>		ER411, ER411D, ER411DD, ER411T	.295 (7.49)
		ER431, ER431D, ER431DD	.400 (10.16)
		RF311	.300 (7.62)
		RF331	.410 (10.41)
 <p style="text-align: center;">“M4” Pad for Centigrid®</p>		172, 172D	.305 (7.75)
		ER114, ER114D, ER114DD, J114, J114D, J114DD	.300 (7.62)
		ER134, ER134D, ER134DD, J134, J134D, J134DD	.400 (10.16)
		RF100	.315 (8.00)
		RF103	.420 (10.67)
 <p style="text-align: center;">“M9” Pad for Centigrid®</p>		122C, A152	.320 (8.13)
		ER116C, J116C	.300 (7.62)
		ER136C, J136C	.400 (10.16)
		RF180	.325 (8.25)
		A150	.305 (7.75)

Notes:

1. Spacer pad material: Polyester film.
2. To specify an “M4” or “M9” spacer pad, refer to the mounting variants portion of the part numbering example in the applicable datasheet.
3. Dimensions are in inches (mm).
4. Unless otherwise specified, tolerance is $\pm .010$ " (.25 mm).
5. Add 10 m Ω to the contact resistance shown in the datasheet.
6. Add 0.01 oz. (0.25 g) to the weight of the relay assembly shown in the datasheet.

APPENDIX: Spreader Pads

Pad designation and bottom view dimensions	Height	For use with the following:	Dim. H Max.
<p style="text-align: center;">"M" Pad <u>5/</u> <u>6/</u></p>		ER411T, J411T, ER412, ER412D ER412DD, J412, J412D, J412DD ER412T, J412T	.388 (9.86)
		712, 712D, 712TN	.393 (9.99)
		ER431T, J431T, ER432, ER432D ER432DD, J432, J432D, J432DD ER432T, J432T	.493 (12.52)
		732, 732D, 732TN	.503 (12.78)
		ER420, J420, ER420D, J420D ER420DD, J420DD, ER421, J421 ER421D, J421D, ER421DD J422D, ER422DD, J422DD, 722	.398 (10.11)
<p style="text-align: center;">"M2" Pad <u>7/</u> <u>8/</u></p>		ER411T ER412, ER412D, ER412DD J412, J412D, J412DD	.441 (11.20)
		712, 712D	.451 (11.46)
		ER421, ER421D, ER421DD 722, 732D	.451 (11.46)
		ER431T ER432, ER432D, ER432DD	.546 (13.87)
		732, 732D	.556 (14.12)
<p style="text-align: center;">"M3" Pad <u>5/</u> <u>6/</u> <u>9/</u></p>		ER411, ER411D, ER411DD, ER411TX ER412X, ER412DX, ER412DDX ER412TX	.388 (9.86)
		712X, 712DX, 712TNX	.393 (9.99)
		ER420X, ER420DX, ER420DDX ER421X, ER421DX, ER421DDX ER422X, ER422DX ER422DDX, 722X, 722DDX	.398 (10.11)
		ER431, ER431D, ER431DD ER431TX ER432X, ER432DX, ER432DDX ER432TX	.493 (12.52)
		732X, 732DX, 732TNX	.503 (12.78)

Notes:

1. Spreader pad material: Diallyl Phthalate.
2. To specify an "M", "M2" or "M3" spreader pad, refer to the mounting variants portion of the part number example in the applicable datasheet.
3. Dimensions are in inches (mm).
4. Unless otherwise specified, tolerance is $\pm .010$ " (0.25 mm).
- 5/. Add 25 m Ω to the contact resistance shown in the datasheet.
- 6/. Add .01 oz. (0.25 g) to the weight of the relay assembly shown in the datasheet.
- 7/. Add 50 m Ω to the contact resistance shown in the datasheet.
- 8/. Add 0.025 oz (0.71 g) to the weight of the relay assembly shown in the datasheet.
- 9/. M3 pad to be used only when the relay has a center pin (e.g. ER411M3-12A, 722XM3-26.)

APPENDIX: Ground Pin Positions

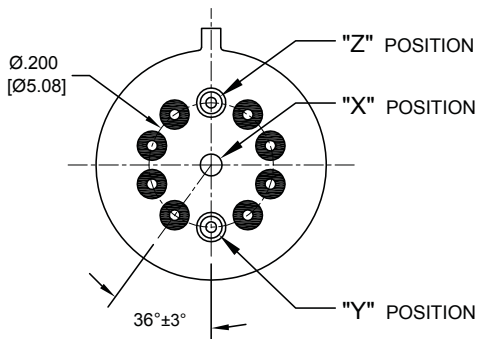

TO-5 Relays:

ER411T, ER412, ER412T, ER420, ER421, ER422, ER431T, ER432, ER432T, 712, 712TN, 400H, 400K, 400V, RF300, RF303, RF341, RF312, RF332, RF310, RF313, RF320, RF323, SI800, SI803, RF700, RF703

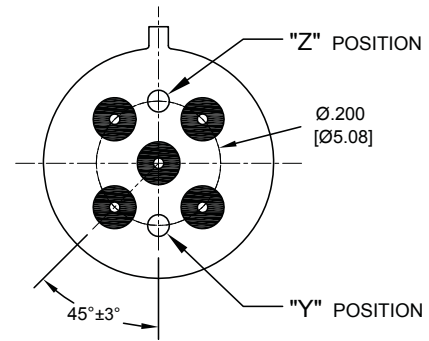

TO-5 Relays:

ER411, ER431, RF311, RF331

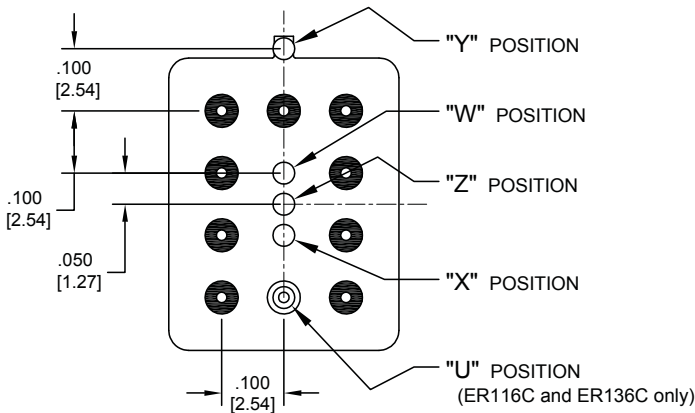

Centigrid® Relays:

RF180, ER116C, 122C, ER136C

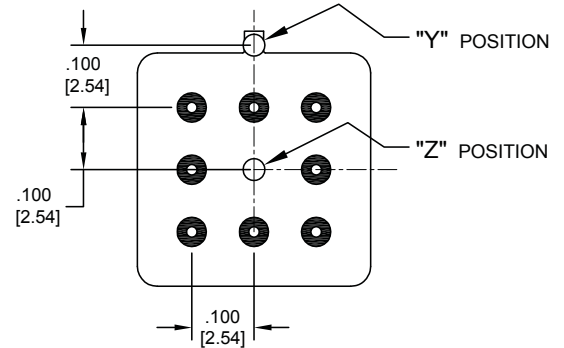

Centigrid® Relays:

RF100, RF103, ER114, ER134, 172

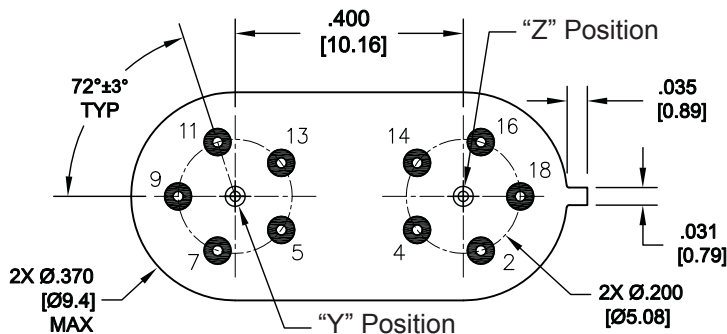

Loopback Relays:

LB363

- Indicates ground pin position
- Indicates glass insulated lead position
- ◎ Indicates ground pin or lead position depending on relay type

NOTES

1. Terminal views shown
2. Dimensions are in inches (mm)
3. Tolerances: ± .010 (±.25) unless otherwise specified
4. Ground pin positions are within .015 (0.38) dia. of true position
5. Ground pin head dia., 0.035 (0.89) ref: height 0.010 (0.25) ref.
6. Lead dia. 0.017 (0.43) nom.