

## LoopBack Relay

### GLB363 Series

*With Built-in AC Bypass Capacitors /  
DC LoopBack Relay*



SERIES DESIGNATION	RELAY TYPE
GLB363	LoopBack Relay, Sensitive Coil, Surface Mount Ground Shield and Stub pins with AC Bypass Capacitors or No capacitor

#### DESCRIPTION

The LoopBack Series relay combines two DPDT electromechanical relays in one package that includes an internal bypass path for Automated Test Equipment (ATE) applications. The LoopBack combines the technology of two Teledyne RF/GRF303 Series relays which eliminates the need for external PCB traces in loop back test applications. This innovation results in superior signal integrity and RF performance, while taking minimal board space. The GLB363 Series is designed for digital signaling application and provides excellent signal integrity up to 16 Gbps data rates.

The internal in-line capacitors allow you to eliminate the footprints for external components, while performing AC bypass functions internal to the relay. The capacitors used feature excellent signal integrity as well as low loss high frequency performance.

A typical loop-back load board application uses the Device Under Test (DUT) to test itself. In this method, the transmitter from the DUT is connected through a

loop back path to the receiver of the DUT. The double pole design of the LoopBack relay is perfectly suited for differential signaling, allowing the relay to provide transmit and receive signals and their inversions to the DUT or through the bypass path.

The internal structure of the LoopBack relay reduces the number of discontinuities and shortens the signal path during loop back testing, providing lower insertion loss and higher signal integrity performance than two SRF303 Series relays. In the normally closed mode (de-energized) the LoopBack relay provides four normally closed contacts. When energized, the moving contacts are connected together across the loop back structure to provide two through paths. The normally closed contacts have similar performance to SGRF303 Series relays.

This LoopBack Relay is available with a surface mount ground shield and J-lead configurations to provide improved high data rate and high frequency performance and ease of surface mount attachment.

The DC LoopBack configuration provides internally shorted paths to allow "auxiliary" full spectrum signal routing.

ENVIRONMENTAL AND PHYSICAL SPECIFICATIONS				
<b>Temperature</b> (Ambient)	<b>Storage</b>	-65°C to +125°C	<b>Enclosure</b>	Hermetically sealed
	<b>Operating</b>	-55°C to +85°C		
<b>Vibration</b> (General Note 1)		10 g's to 500 Hz	<b>Shock</b> (General Note 1)	30 g's, 6ms half sine
<b>Weight</b>	<b>GLB363</b>	0.16 oz. (4.53g) max.	<b>GLB363</b>	0.18 oz. (5.10g) max.

**SERIES GLB363**  
TYPICAL RF Characteristics (See RF Notes on next page)

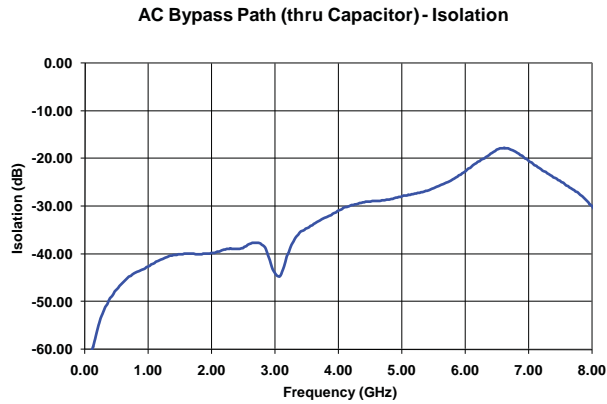
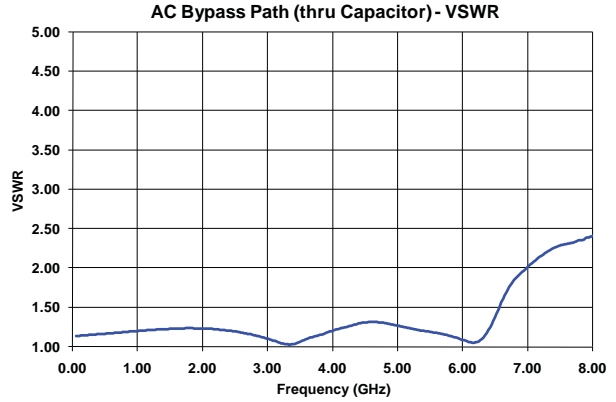
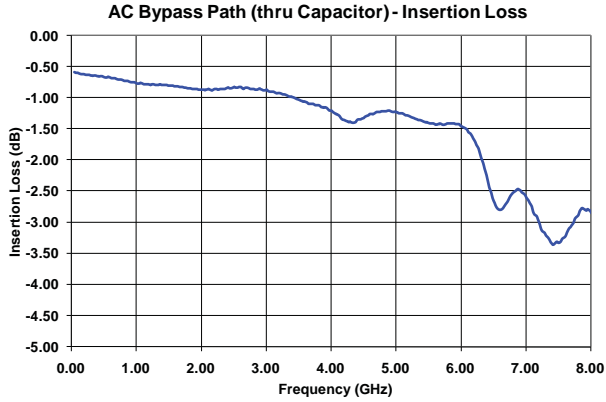

**Normally Closed RF Performance**

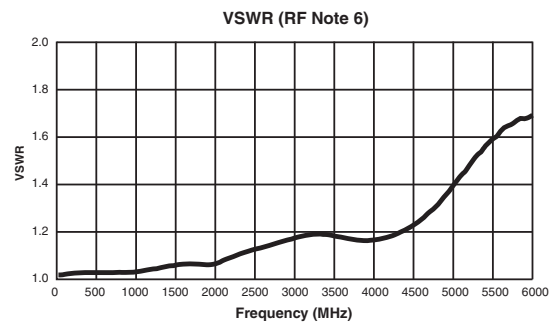
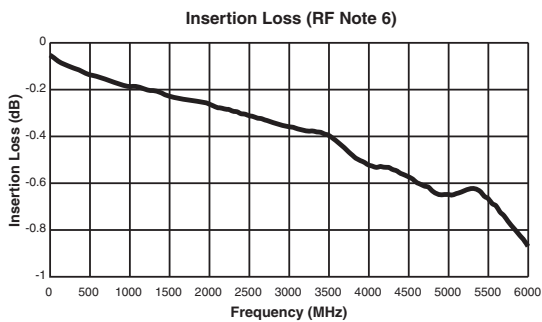
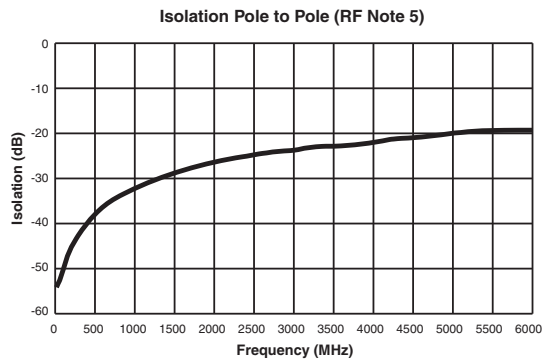
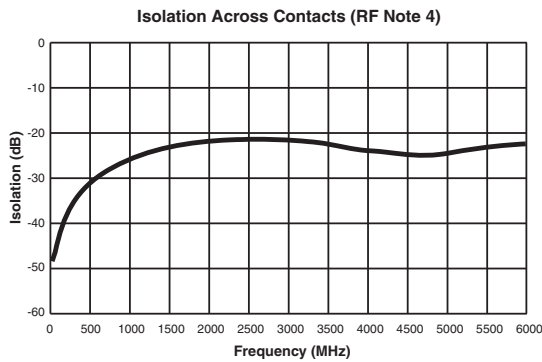

**SERIES GLB363**  
**GENERAL ELECTRICAL SPECIFICATIONS (@ 25 °C unless otherwise noted)**

<b>Contact Arrangement</b>	Special (See Schematic on page 5)
<b>Rated Duty</b>	Continuous
<b>Contact Resistance</b>	0.200 $\Omega$ max. initial (measured 1/8" from the header)
<b>Contact Load Rating</b>	Resistive: 1Amp/28Vdc Low level: 10 to 50 $\mu$ A, 10 to 50 mV
<b>Contact Life Ratings</b>	5,000,000 cycles (typical) at low level
<b>Operate Time</b>	4.0 mS max.
<b>Release Time</b>	3.0 mS max.
<b>Insulation Resistance</b>	1,000 M $\Omega$ min. between mutually isolated terminals
<b>Dielectric Strength</b>	350 Vrms (60 Hz) @ atmospheric pressure

**DETAILED ELECTRICAL SPECIFICATIONS (@25°C)**

<b>BASE PART NUMBERS</b>	<b>GLB363-x-5</b>	<b>GLB363-x-12</b>
<b>Coil Voltage, Nominal (Vdc)</b>	5.0	12.0
<b>Coil Resistance (Ohms <math>\pm</math>20%)</b>	56	400
<b>Pick-up Voltage (Vdc max.)</b>	3.6	9.0
<b>Coil Operating Power (mW)</b>	450	360

**RF NOTES**

- Test conditions:
  - Fixture: .031" copper clad, reinforced PTFE, RT/duroid® 6002 with SMA connectors. (RT/duroid® is a registered trademark of Rogers Corporation.)
  - Room ambient temperature.
  - Terminals not tested were terminated with 50-ohm load.
  - Contact signal level: -10 dBm.
  - No. of test samples: 4.
- Data presented herein represents typical characteristics and is not intended for use as specification limits.
- Data is per pole, except for pole-to-pole data.
- Data is the average from readings taken on all open contacts.
- Data is the average from readings taken on poles with coil energized and de-energized.
- Data is the average from readings taken on all closed contacts.
- Test fixture effect de-embedded from frequency and time response data.

**SERIES GLB363**  
**TYPICAL Single-Ended Signal Integrity Characteristics @ 10 Gbps**

**AC Bypass Path**

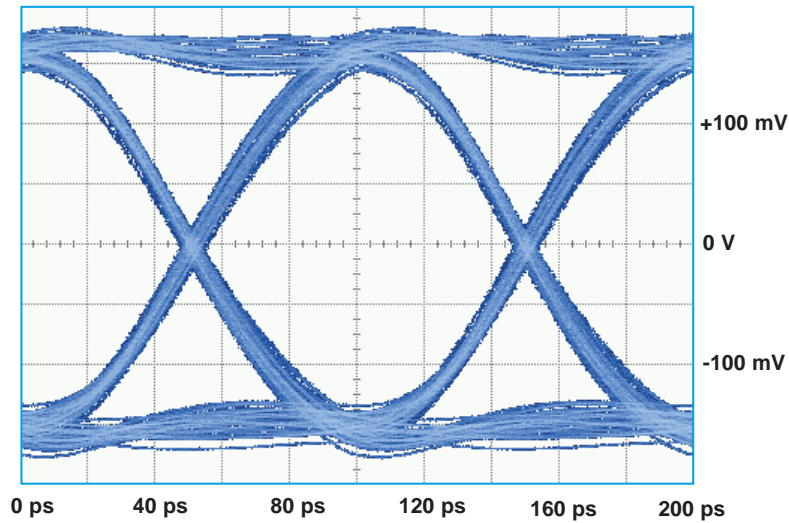

Bit Rate	Eye Height	Eye Width	Jitter <sub>p-p</sub>
10 Gbps	254.3 mV	88.64 ps	8.89 ps

**SERIES GLB363**  
**TYPICAL Differential Signal Integrity Characteristics @ 10 Gbps**

**AC Bypass Path**

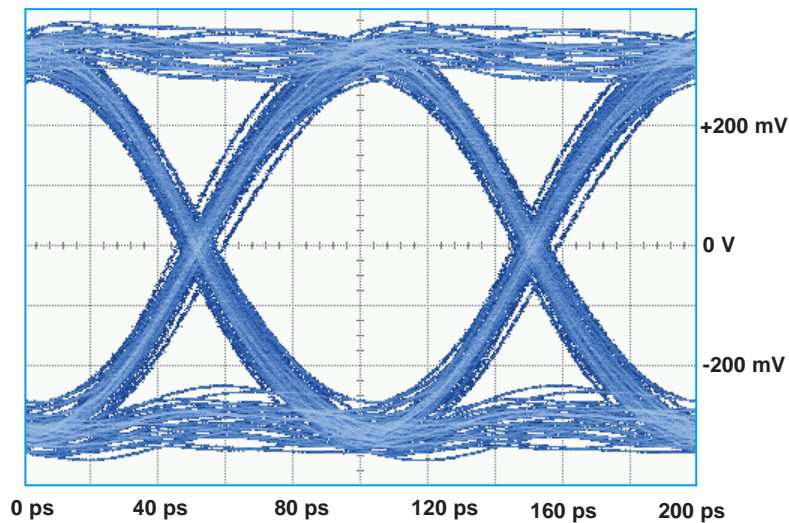

Bit Rate	Eye Height	Eye Width	Jitter <sub>p-p</sub>
10 Gbps	492.1 mV	84.29 ps	15.55 ps

**SERIES GLB363**  
**TYPICAL Single-Ended Signal Integrity Characteristics @ 16 Gbps**

**AC BYPASS PATH (Capacitor Path)**

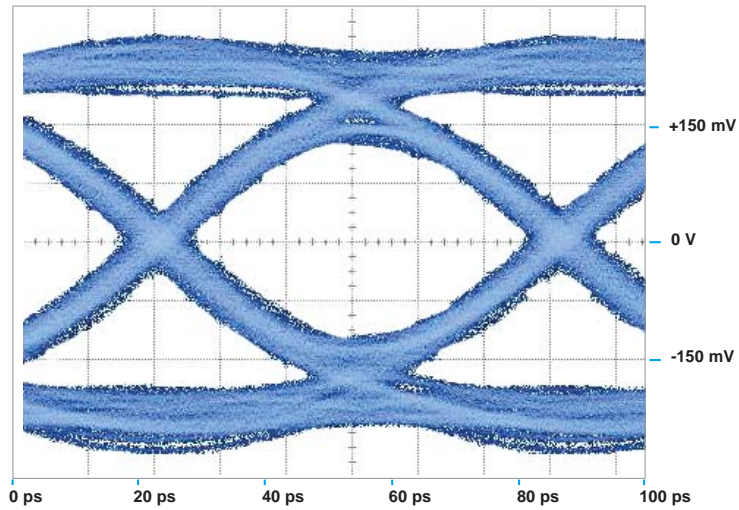

Bit Rate	Eye Height	Eye Width	Jitter <sub>P-P</sub>
16 Gbps	173 mV	48.3 ps	12.67 ps

**Normally Closed Path (Through Path)**

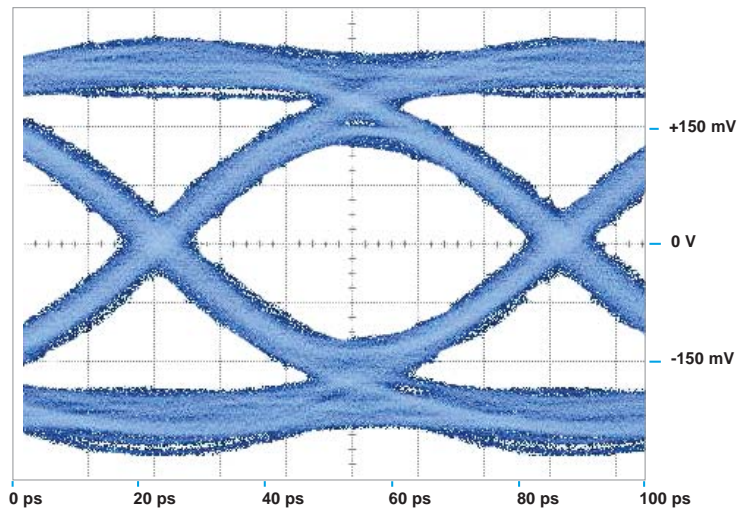

Bit Rate	Eye Height	Eye Width	Jitter <sub>P-P</sub>
16 Gbps	173 mV	48.3 ps	12.67 ps

**PATTERN GENERATOR SETTINGS**

- 16 Gbps Random Pulse Pattern Generator
- $2^{31} - 1$  PRBS signal
- PRBS output of 500 mV<sub>P-P</sub> (nominal)
- RF PCB effect (negligible) not removed from measurement
- Data shown is typical of both poles

**SERIES GLB363**  
**OUTLINE DIMENSIONS**

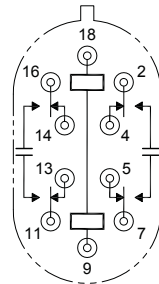
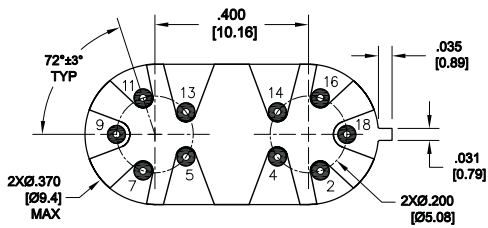
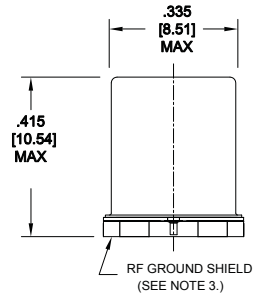
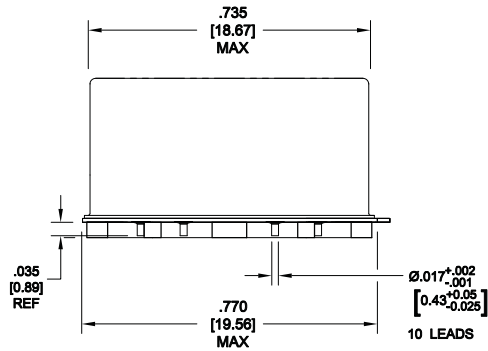

—||— CAPACITOR

**SCHEMATIC - TERMINAL VIEW**  
PIN NUMBERS ARE FOR REFERENCE ONLY, NOT MARKED ON RELAY

**NOTES:**

1. DIMENSIONS ARE IN INCHES. METRIC EQUIVALENTS (MILLIMETERS) ARE SHOWN IN [ X.XX ].
2. TOLERANCE (UNLESS OTHERWISE SPECIFIED): ±.010 INCH [±0.25 mm]
3. FOR BEST RF PERFORMANCE, SOLDER BOTTOM OF RF GROUND SHIELD TO RF GROUND PLANE OF PC BOARD.

**Teledyne Part Numbering System for LoopBack Relays**

GLB363 - 100 - 5

Relay Series \_\_\_\_\_

Coil Voltage  
5 = 5V  
12 = 12V

Capacitance  
000 = No Capacitor  
100 = 100nF  
010 = 10nF  
220 = 220nF

**NOTES:**

Relay leads are gold plated with a typical thickness of 25-40 µin. Ground shield is gold plated with a typical thickness of 10-30µin.

**SERIES GLB363  
APPLICATION NOTE**

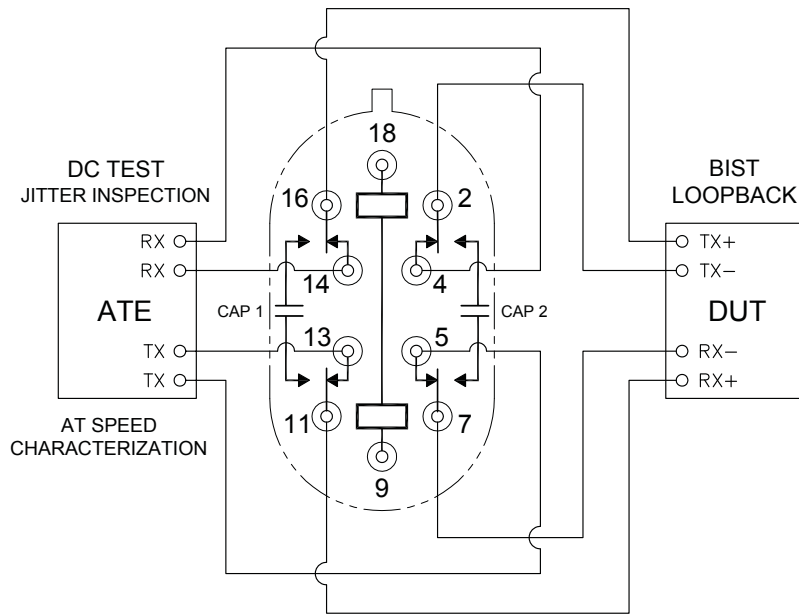

*(Contacts shown in De-Energized position)*

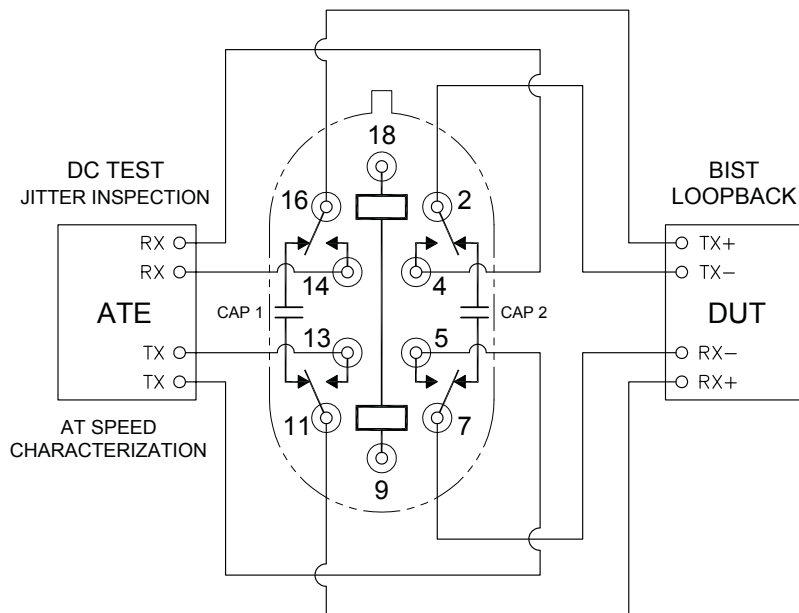

*(Contacts shown in Energized position)*

**NOTES:**  
Coil Pins 9&18 are not polarity sensitive.  
Pin assignment shown as terminal view.

**SERIES GLB363**  
**APPLICATION NOTE (Applicable to No Capacitor Model)**

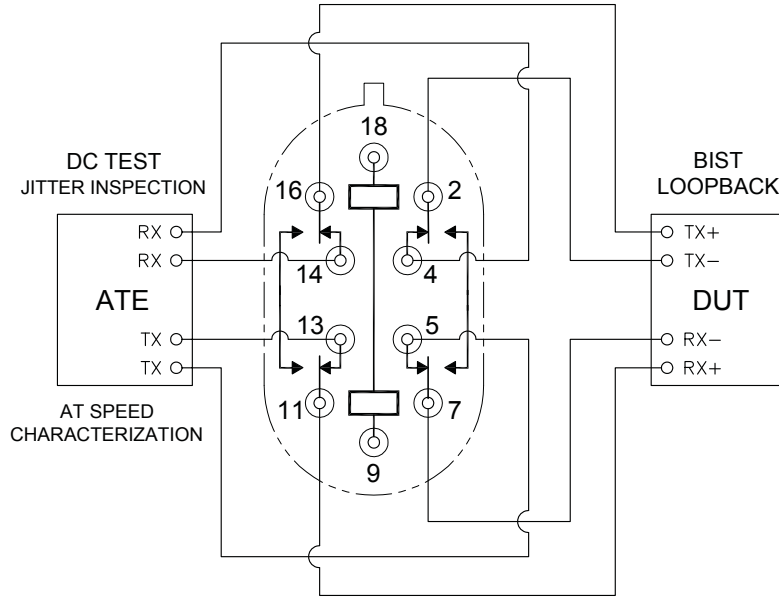

(Contacts shown in *De-Energized* position)

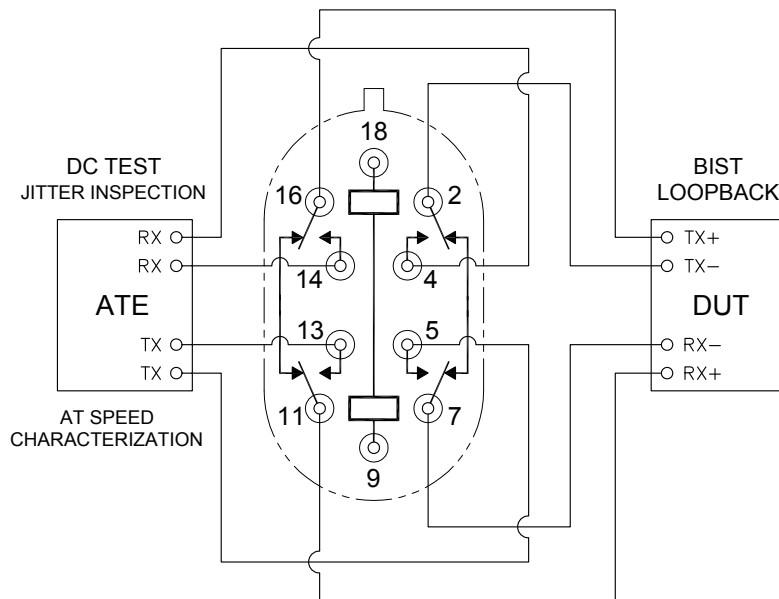

(Contacts shown in *Energized* position)

**NOTES:**  
Coil Pins 9&18 are not polarity sensitive.  
Pin assignment shown as terminal view.