



CENTIGRID® SURFACE MOUNT COMMERCIAL RELAYS DPDT



SERIES	RELAY TYPE
S114	DPDT basic relay
S114D	DPDT relay with internal diode for coil transient suppression
S114DD	DPDT relay with internal diodes for coil transient suppression and polarity reversal protection

DESCRIPTION

The Series S114 Surface Mount Centigrid® Relay is an ultraminiature, hermetically sealed, armature relay. The low profile height (.360") and .100" lead spacing make it ideal for applications where extreme packaging density and/or close PC board spacing are required. The specially formed leads are pre-tinned to make the relays ideal for most types of surface mount solder reflow processes.

The basic design and internal construction are identical to the Series 114 Centigrid® relays, and are capable of meeting Teledyne Relays' T2R® requirements. The following unique construction features and manufacturing techniques provide overall high reliability and excellent resistance to environmental extremes:

The S114 feature:

- All welded construction.
- Unique uni-frame design providing high magnetic efficiency and mechanical rigidity.
- High force/mass ratios for resistance to shock and vibration.
- Advanced cleaning techniques provide maximum assurance of internal cleanliness.
- Precious metal alloy contact material with gold plating assures excellent high current and dry circuit switching capabilities.

The Series S114D and S114DD relays have internal discrete silicon diodes for coil suppression and polarity reversal protection

Part Numbering System

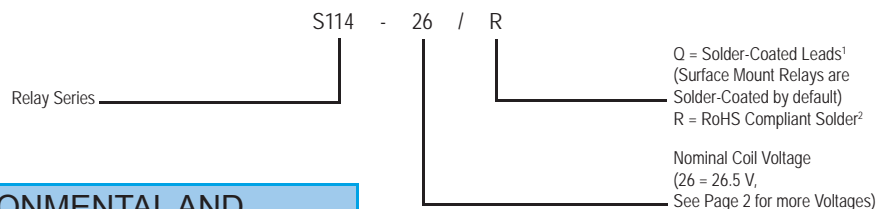

ENVIRONMENTAL AND PHYSICAL SPECIFICATIONS

Temperature (Operating)	-55°C to +85°C
Vibration (General Note I)	30 g's to 3000 Hz
Shock (General Note I)	50 g's, 6ms half sine
Acceleration	50 g's
Enclosure	Hermetically sealed
Weight	0.15 oz. (4.3g) max.
Reflow Temperature	260°C max. temp. 1 min. max

INTERNAL CONSTRUCTION

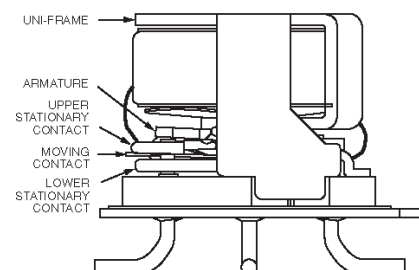

SERIES S114
GENERAL ELECTRICAL SPECIFICATIONS (-55 °C to 85 °C unless otherwise noted. See notes 2 & 3.)

Contact Arrangement	2 Form C (DPDT)	
Rated Duty	Continuous	
Contact Resistance	0.10 Ω max.	
Contact Load Rating (DC)	Resistive: 1 A / 28 Vdc Inductive: 200 mA / 28 Vdc (320mH) Lamp: 100 mA / 28 Vdc (320mH) Low level: 10 to 50 μA @ 10 to 50 mV	
Contact Load Rating (AC)	Resistive: 250 mA / 115Vac, 60 and 400 Hz (Case not grounded) 100 mA / 115 Vac, 60 and 400 Hz (Case grounded)	
Contact Life Ratings	10,000,000 cycles (typical) at low level 1,000,000 cycles (typical) at 0.5 A / 28 Vdc resistive 100,000 cycles min. at all other loads specified above	
Contact Overload Rating	2 A / 28 Vdc Resistive (100 cycles min.)	
Coil Operating Power	450 mW typical at nominal rated voltage	
Contact Carry Rating	Contact Factory	
Operate Time	2.0 msec max. at nominal rated coil voltage	
Release Time	S114: 1.5 ms max.	S114D, S114DD: 4.0 ms max.
Contact Bounce	1.5 msec max.	
Intercontact Capacitance	0.4 pf typical	
Insulation Resistance	10,000 MΩ min. between mutually isolated terminals	
Dielectric Strength	500 Vrms (60 Hz) @ atmospheric pressure	
Negative Coil Transient (Vdc)	1.0 Vdc Max.	
Diode P.I.V. (Vdc)	100 Vdc Min.	

DETAILED ELECTRICAL SPECIFICATIONS (@25°C)

BASE PART NUMBERS (S114, S114D, S114DD)		S114-5	S114-6	S114-9	S114-12	S114-18	S114-26	
		S114D-5 S114DD-5	S114D-6 S114DD-6	S114D-9 S114DD-9	S114D-12 S114DD-12	S114D-18 S114DD-18	S114D-26 S114DD-26	
Coil Voltage	Nom.	5.0	6.0	9.0	12.0	18.0	26.5	
	Max.	5.8	8.0	12.0	16.0	24.0	32.0	
Coil Resistance (Ohms ±10% @25°C)	S114, S114D	50	98	220	390	880	1560	
	S114D	39	78	220	390	880	1560	
Coil Current (S114DD) (mAdc @25°C)	(Note 5)	Min.	93.2	57.8	33.0	25.6	17.5	14.8
		Max.	128.2	74.8	42.9	32.8	22.1	18.5
Pick-up Voltage (Vdc, Max)	S114, S114D	3.5	4.5	6.8	9.0	13.5	18.0	
	S114DD	4.0	5.0	7.8	10.0	14.5	19.0	
Drop-out Voltage (Vdc)	S114, S114D	Min.	0.14	0.18	0.35	0.41	0.59	0.89
		Max.	2.3	3.2	4.9	6.5	10.0	13.0
	S114DD	Min.	0.6	0.7	0.8	0.9	1.1	1.4
		Max.	2.8	3.4	5.6	6.5	10.0	13.0

**SERIES S114
OUTLINE DIMENSIONS**

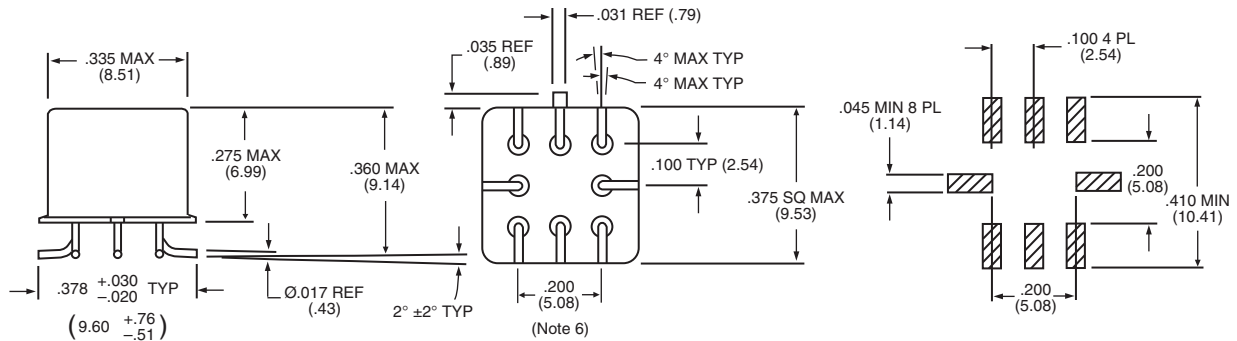

Dimensions are shown in Inches (Millimeters)
(Viewed From Terminals)

SCHEMATIC DIAGRAMS

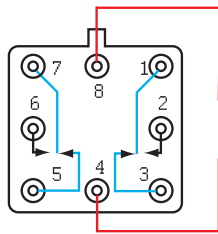

S114

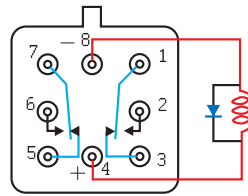

S114D

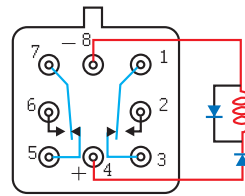

S114DD

NOTES:

1. RELAY CONTACTS WILL EXHIBIT NO CHATTER IN EXCESS OF 10 MSEC OR TRANSFER IN EXCESS OF 1 MSEC.
2. "TYPICAL" CHARACTERISTICS ARE BASED ON AVAILABLE DATA AND ARE BEST ESTIMATES. NO ON-GOING VERIFICATION TESTS ARE PERFORMED.
3. UNLESS OTHERWISE SPECIFIED, PARAMETERS ARE INITIAL VALUES.
4. FOR REFERENCE ONLY. COIL RESISTANCE NOT DIRECTLY MEASURABLE AT RELAY TERMINALS DUE TO INTERNAL SERIES DIODE.
5. MEASURED AT NOMINAL VOLTAGE FOR 5 SEC. MAX.
6. POSITION OF LEADS AS THEY EMERGE FROM RELAY BASE.
7. LEADS WILL FIT NOTED PAD LAYOUT WITH NO OVERHANG.
8. LEAD ENDS ARE COPLANAR WITHIN .008" WIDE TOLERANCE ZONE.
9. TERMINALS COATED WITH SN60 OR SN63 SOLDER PER QQ-S-571. KOVAR EXPOSED AT SHEARED END OF LEADS.

PERFORMANCE CURVES (Note 2)

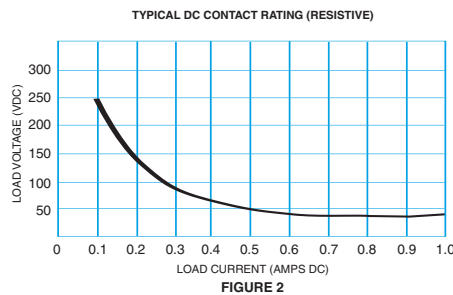
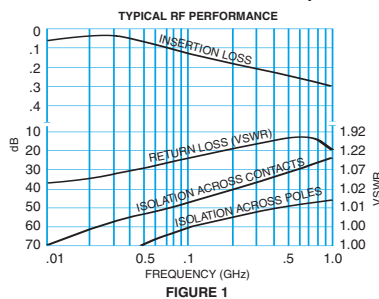

GENERAL NOTES

1. Relay contacts will exhibit no chatter in excess of 10 μ sec or transfer in excess of 1 μ sec.
2. "Typical" characteristics are based on available data and are best estimates. No on-going verification tests are performed.
3. Unless otherwise specified, parameters are initial values.
4. Relays can be supplied with a spacer pad. See appendix.

APPENDIX: Spacer Pads

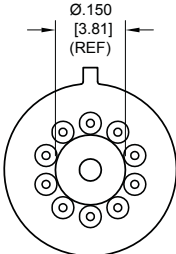
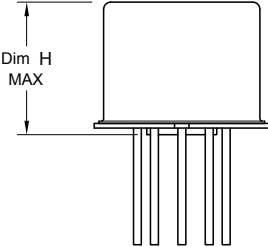
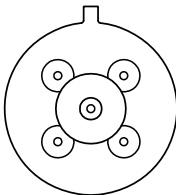
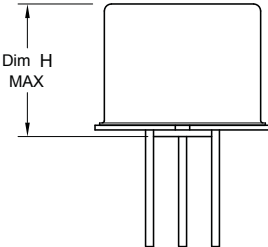
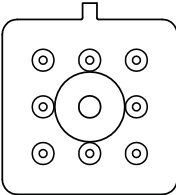
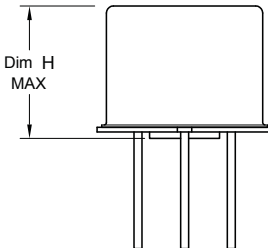
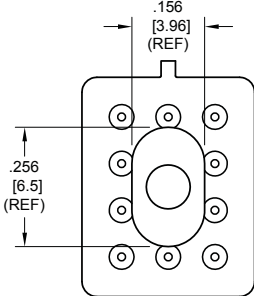
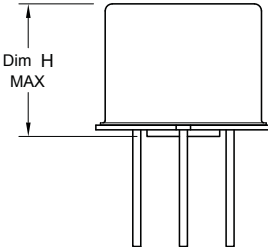
Pad designation and bottom view dimensions	Height	For use with the following:	Dim. H Max.
 <p style="text-align: center;">“M4” Pad for TO-5</p>		ER412, ER412D, ER412DD	.295 (7.49)
		712, 712D, 712TN, RF300, RF310, RF320 RF700, RF703	.300 (7.62)
		ER420, ER420D, ER420DD, 421, ER421D, ER421DD, ER422, ER422D, ER422DD, 722, 722D, RF341	.305 (7.75)
		ER431T, ER432T, ER432, ER432D, ER432DD	.400 (10.16)
		732, 732D, 732TN, RF303, RF313, RF323	.410 (10.41)
		RF312, RF332 SI800, SI803	.350 (8.89)
 <p style="text-align: center;">“M4” Pad for TO-5</p>		ER411, ER411D, ER411DD, ER411T	.295 (7.49)
		ER431, ER431D, ER431DD	.400 (10.16)
		RF311	.300 (7.62)
		RF331	.410 (10.41)
 <p style="text-align: center;">“M4” Pad for Centigrid®</p>		172, 172D	.305 (7.75)
		ER114, ER114D, ER114DD, J114, J114D, J114DD	.300 (7.62)
		ER134, ER134D, ER134DD, J134, J134D, J134DD	.400 (10.16)
		RF100	.315 (8.00)
		RF103	.420 (10.67)
 <p style="text-align: center;">“M9” Pad for Centigrid®</p>		122C, A152	.320 (8.13)
		ER116C, J116C	.300 (7.62)
		ER136C, J136C	.400 (10.16)
		RF180	.325 (8.25)
		A150	.305 (7.75)

Notes:

1. Spacer pad material: Polyester film.
2. To specify an “M4” or “M9” spacer pad, refer to the mounting variants portion of the part numbering example in the applicable datasheet.
3. Dimensions are in inches (mm).
4. Unless otherwise specified, tolerance is $\pm .010$ " (.25 mm).
5. Add 10 m Ω to the contact resistance shown in the datasheet.
6. Add 0.01 oz. (0.25 g) to the weight of the relay assembly shown in the datasheet.

APPENDIX: Spreader Pads

Pad designation and bottom view dimensions	Height	For use with the following:	Dim. H Max.
<p style="text-align: center;">"M" Pad <u>5/ 6/</u></p>		ER411T, J411T, ER412, ER412D ER412DD, J412, J412D, J412DD ER412T, J412T	.388 (9.86)
		712, 712D, 712TN	.393 (9.99)
		ER431T, J431T, ER432, ER432D ER432DD, J432, J432D, J432DD ER432T, J432T	.493 (12.52)
		732, 732D, 732TN	.503 (12.78)
		ER420, J420, ER420D, J420D ER420DD, J420DD, ER421, J421 ER421D, J421D, ER421DD J422D, ER422DD, J422DD, 722	.398 (10.11)
<p style="text-align: center;">"M2" Pad <u>7/ 8/</u></p>		ER411T ER412, ER412D, ER412DD J412, J412D, J412DD	.441 (11.20)
		712, 712D	.451 (11.46)
		ER421, ER421D, ER421DD 722, 732D	.451 (11.46)
		ER431T ER432, ER432D, ER432DD	.546 (13.87)
<p style="text-align: center;">"M3" Pad <u>5/ 6/ 9/</u></p>		ER411, ER411D, ER411DD, ER411TX ER412X, ER412DX, ER412DDX ER412TX	.388 (9.86)
		712X, 712DX, 712TNX	.393 (9.99)
		ER420X, ER420DX, ER420DDX ER421X, ER421DX, ER421DDX ER422X, ER422DX ER422DDX, 722X, 722DDX	.398 (10.11)
		ER431, ER431D, ER431DD ER431TX ER432X, ER432DX, ER432DDX ER432TX	.493 (12.52)
		732X, 732DX, 732TNX	.503 (12.78)

Notes:

1. Spreader pad material: Diallyl Phthalate.
2. To specify an "M", "M2" or "M3" spreader pad, refer to the mounting variants portion of the part number example in the applicable datasheet.
3. Dimensions are in inches (mm).
4. Unless otherwise specified, tolerance is $\pm .010$ " (0.25 mm).
- 5/. Add 25 m Ω to the contact resistance shown in the datasheet.
- 6/. Add .01 oz. (0.25 g) to the weight of the relay assembly shown in the datasheet.
- 7/. Add 50 m Ω to the contact resistance shown in the datasheet.
- 8/. Add 0.025 oz (0.71 g) to the weight of the relay assembly shown in the datasheet.
- 9/. M3 pad to be used only when the relay has a center pin (e.g. ER411M3-12A, 722XM3-26.)

APPENDIX: Ground Pin Positions

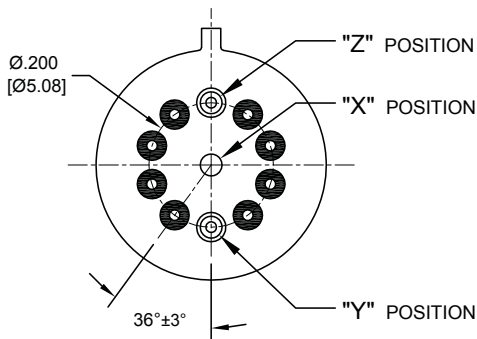

TO-5 Relays:

ER411T, ER412, ER412T, ER420, ER421, ER422, ER431T, ER432, ER432T, 712, 712TN, 400H, 400K, 400V, RF300, RF303, RF341, RF312, RF332, RF310, RF313, RF320, RF323, SI800, SI803, RF700, RF703

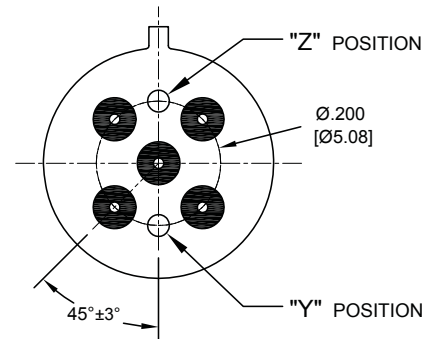

TO-5 Relays:

ER411, ER431, RF311, RF331

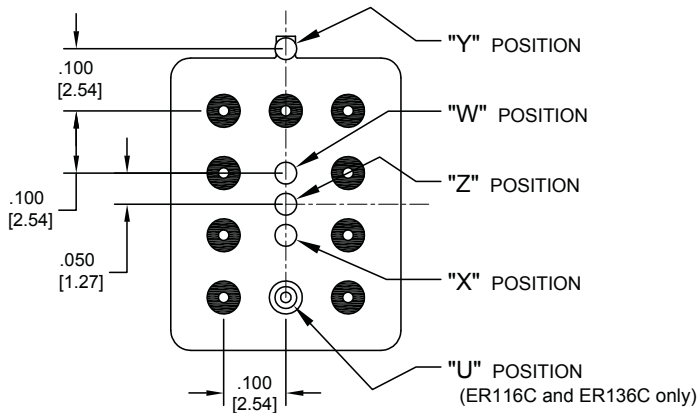

Centigrad® Relays:

RF180, ER116C, 122C, ER136C

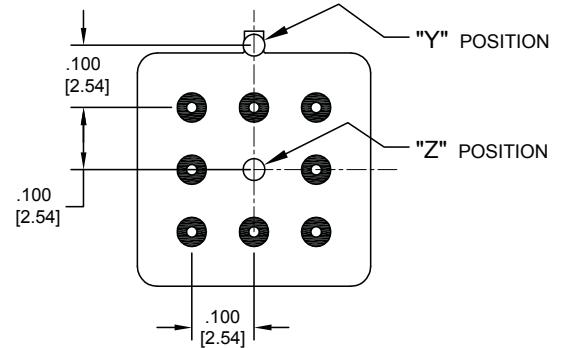

Centigrad® Relays:

RF100, RF103, ER114, ER134, 172

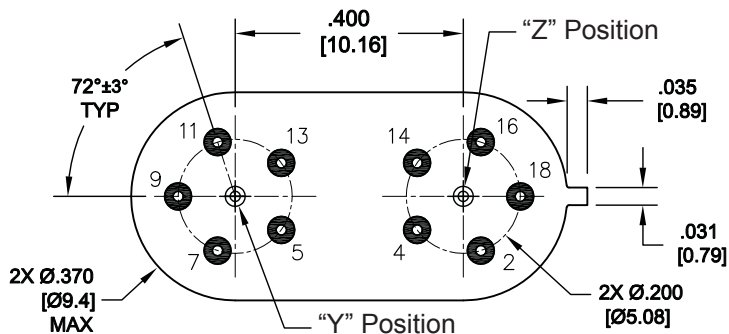

Loopback Relays:

LB363

- Indicates ground pin position
- Indicates glass insulated lead position
- ◎ Indicates ground pin or lead position depending on relay type

NOTES

1. Terminal views shown
2. Dimensions are in inches (mm)
3. Tolerances: $\pm .010$ ($\pm .25$) unless otherwise specified
4. Ground pin positions are within .015 (0.38) dia. of true position
5. Ground pin head dia., 0.035 (0.89) ref: height 0.010 (0.25) ref.
6. Lead dia. 0.017 (0.43) nom.